



Broadband Modem and Residential Gateway

Last Updated: Mar 18, 2024

A broadband (smart home) gateway is an appliance that delivers broadband data, voice and video services to a home or customer premises. It is the point of entry for Internet services to the home and its performance is key to the quality of experience provided to the end user.

These days, most end users equate Wi-Fi performance in the home with the overall service provided by the broadband operator. More and more people also rely on their broadband data service for TV and video and increasingly expect to manage all of those services with voice-controlled applications. As a result, the residential gateway is moving out of the closet and becoming a central hub for wireless voice, data and video service delivery across the home.

NXP can offer a complete portfolio of solutions for modern residential gateways including gigabit-class network processors with hardware packet processing and QoS, leading-edge Wi-Fi, IOT radios and other supporting devices such as power management ICs. Further, NXP also offers a vertically integrated, extensively tested, power and performance optimized, Linux®-based OpenWRT Gateway application solutions kit (ASK) to customers inclined to build multiple market network products, such as embedded routers or programmable L3 switches based on the Layerscape Communication Processors.

Broadband Modem and Residential Gateway Block Diagram

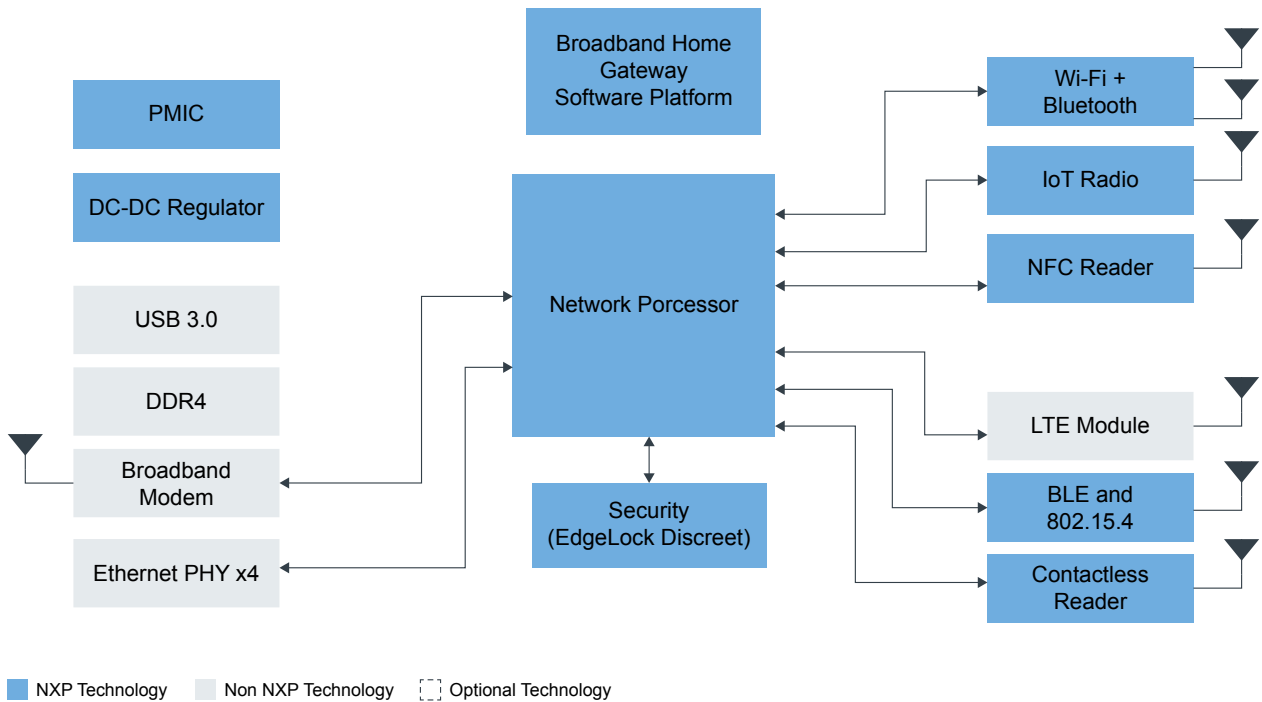

Recommended Products for Broadband Modem and Residential Gateway

Network Processor	<ul style="list-style-type: none"> • LS1046A: Layerscape® 1046A and 1026A Processors • LS1043A: Layerscape® 1043A and 1023A Processors • LS1012A: Layerscape® 1012A Low Power Processor
Software	<ul style="list-style-type: none"> • Layerscape 1046A Processor Broadband Home Router Application Solutions Kit • Layerscape 1043A Processor Broadband Home Router Application Solutions Kit • Layerscape 1012A Broadband Home Router Application Solutions Kit
PMIC	<ul style="list-style-type: none"> • FS5600: Automotive Dual Buck Regulator and Controller with Voltage Monitors and Watchdog Timer • PF81-PF82: 12-Channel Power Management Integrated Circuit (PMIC) for High-Performance Processing Applications • VR5100: Multi-Output DC-DC Regulator for Low Power LS1 Communication Processors

NFC	<ul style="list-style-type: none"> • PN7160: NFC Plug and Play Controller with Integrated Firmware and NCI Interface
Power Management	<ul style="list-style-type: none"> • FS5600: Automotive Dual Buck Regulator and Controller with Voltage Monitors and Watchdog Timer • VR5100: Multi-Output DC-DC Regulator for Low Power LS1 Communication Processors
Security (EdgeLock Discrete)	<ul style="list-style-type: none"> • SE050: EdgeLock[®] SE050: Plug and Trust Secure Element Family – Enhanced IoT security with high flexibility • SE051: EdgeLock[®] SE051: Proven, Easy-to-Use IoT Security Solution with Support for Updatability and Custom Applets • EDGELOCK-A5000: EdgeLock[®] A5000 Plug and Trust Secure Authenticator: Authentication Made Secure, Scalable and Easy
Wireless	<ul style="list-style-type: none"> • KW41Z: Kinetis[®] KW41Z-2.4 GHz Dual Mode: Bluetooth[®] Low Energy and 802.15.4 Wireless Radio Microcontroller (MCU) based on Arm[®] Cortex[®]-M0+ Core
Wi-Fi + Bluetooth	<ul style="list-style-type: none"> • 88W8987: 2.4/5 GHz Dual-Band 1x1 Wi-Fi[®] 5 (802.11ac) + Bluetooth[®] 5.2 Solution • 88W8997: 2.4/5 GHz Dual-Band 2x2 Wi-Fi[®] 5 (802.11ac) + Bluetooth[®] 5.3 Solution
IoT Radio	<ul style="list-style-type: none"> • JN5189_88_T: JN5189/88 (T): High-Performance and Ultra-Low-Power MCUs for Zigbee[®] and Thread with Built-In NFC Option
NFC Reader	<ul style="list-style-type: none"> • PN7160: NFC Plug and Play Controller with Integrated Firmware and NCI Interface

View our complete solution for [Broadband Modem and Residential Gateway](#).

Note: The information on this document is subject to change without notice.

www.nxp.com

NXP and the NXP logo are trademarks of NXP B.V. All other product or service names are the property of their respective owners. The related technology may be protected by any or all of patents, copyrights, designs and trade secrets. All rights reserved. © 2024 NXP B.V.