



V2X Communications

Last Updated: Nov 16, 2023

Vehicle-to-Everything (V2X) technology enables cars to communicate with their surroundings and makes driving safer and more efficient for everyone. By making the invisible visible, V2X warns the driver of road hazards, helping reduce traffic injuries and fatalities. In addition to improving safety, V2X helps to optimize traffic flow, reduce traffic congestion and lessen the environmental impact of transportation.

We provide a complete solution for Vehicle-to-Vehicle (V2V) and Vehicle-to-Infrastructure (V2I) communications for active safety systems and intelligent transport system (ITS) management.

V2X Communications Block Diagram

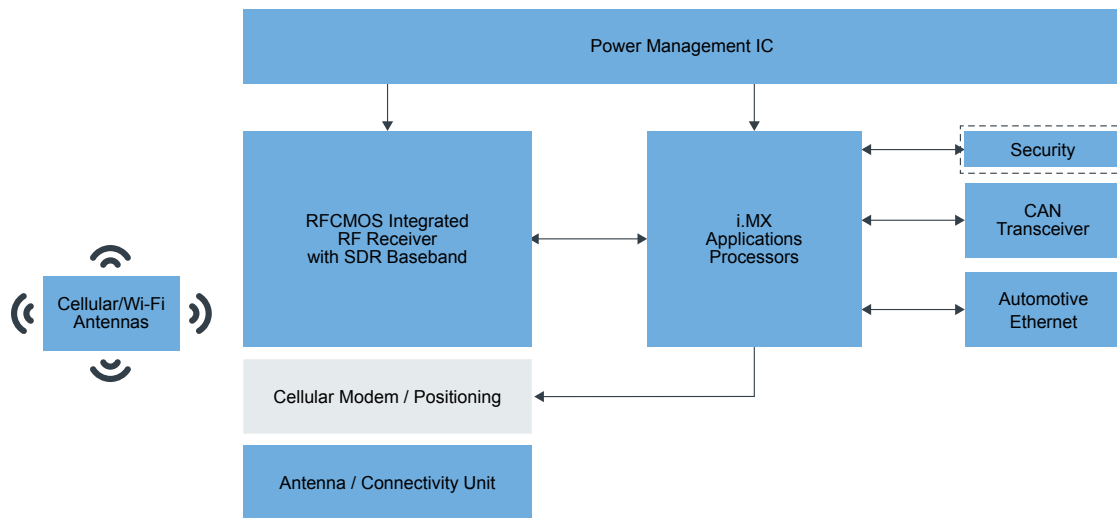

■ NXP Technology
 ■ Non NXP Technology
 Optional Technology

Recommended Products for V2X Communications

i.MX Applications Processors	<ul style="list-style-type: none"> • i.MX6SX: i.MX 6SoloX Processors - Heterogeneous Processing with Arm® Cortex®-A9 and Cortex-M4 Cores • i.MX8X: i.MX 8X Family – Arm® Cortex®-A35, 3D Graphics, 4K Video, DSP, Error Correcting Code on DDR
Automotive Ethernet	<ul style="list-style-type: none"> • TJA1121: TJA1121, MACsec Enabled ASIL B Compliant Automotive Ethernet 1000BASE-T1 PHY Transceiver • TJA1120: TJA1120, ASIL B Compliant Automotive Ethernet 1000BASE-T1 PHY Transceiver • TJA1104: TJA1104, MACsec Enabled ASIL B Compliant Automotive Ethernet 100BASE-T1 PHY Transceiver • TJA1103: TJA1103, ASIL B Compliant Automotive Ethernet 100BASE-T1 PHY Transceiver
CAN Transceiver	<ul style="list-style-type: none"> • TJA144x: Automotive CAN FD Transceiver Family • TJA1463: CAN Signal Improvement Capability Transceiver with Sleep Mode

Dual RF Transceiver	<ul style="list-style-type: none"> • TEF5100: V2X RF Transceiver
Power Management IC	<ul style="list-style-type: none"> • FS5600: Automotive Dual Buck Regulator and Controller with Voltage Monitors and Watchdog Timer • PF7100: 7-Channel Power Management Integrated Circuit for High Performance Applications, Fit for ASIL B Safety Level • VR5500: High Voltage PMIC with Multiple SMPS • VR5510: Multi-Channel (9) PMIC for S32G Processor – 8 High Power, 1 Low Power, Fit for ASIL D Safety Level • FS86: Safety System Basis Chip For Domain Controller, Fit For ASIL B and D • PF81-PF82: 12-Channel Power Management Integrated Circuit (PMIC) for High-Performance Processing Applications • PF5020: Multi-Channel (5) PMIC for Automotive Applications – 4 High Power and 1 Low Power, Fit for ASIL B Safety Level
Security	<ul style="list-style-type: none"> • SXF1800: Secure Element IC for V2X Communication
Software Defined Radio Baseband	<ul style="list-style-type: none"> • SAF5400: RoadLINK® SAF5400 Single Chip Modem for V2X
Wi-Fi / Antennas	<ul style="list-style-type: none"> • AW693: 2x2 Dual-Band (5-7 GHz), 1x1 (2.4 GHz) Concurrent Dual Wi-Fi 6/6E and Bluetooth 5.3 Combo Solution
Wi-Fi / Antennas	<ul style="list-style-type: none"> • AW693: 2x2 Dual-Band (5-7 GHz), 1x1 (2.4 GHz) Concurrent Dual Wi-Fi 6/6E and Bluetooth 5.3 Combo Solution

View our complete solution for [V2X Communications](#).

Note: The information on this document is subject to change without notice.

www.nxp.com

NXP and the NXP logo are trademarks of NXP B.V. All other product or service names are the property of their respective owners. The related technology may be protected by any or all of patents, copyrights, designs and trade secrets. All rights reserved. © 2024 NXP B.V.