

AN1513

Mounting Techniques and Plumbing Options of Motorola's MPX Series Pressure Sensors

Prepared by: Brian Pickard
 Sensor Products Division
 Semiconductor Products Sector

INTRODUCTION

Motorola offers a wide variety of ported, pressure sensing devices which incorporate a hose barb and mounting tabs. They were designed to give the widest range of design flexibility. The hose barbs are 1/8" (≈3 mm) diameter and the tabs have #6 mounting holes. These sizes are very common and should make installation relatively simple. More importantly, and often overlooked, are the techniques used in mounting and adapting the ported pressure sensors. This application note provides some recommendations on types of fasteners for mounting, how to use them with Motorola sensors, and identifies some suppliers. This document also recommends a variety of hoses, hose clamps, and their respective suppliers.

This information applies to all Motorola MPX pressure sensors with ported packages, which includes the packages shown in Figure 1.

A review of recommended mounting hardware, mounting torque, hose applications, and hose clamps is also provided for reference.

MOUNTING HARDWARE

Mounting hardware is an integral part of package design. Different applications will call for different types of hardware. When choosing mounting hardware, there are three important factors:

- permanent versus removable
- application
- cost

The purpose of mounting hardware is not only to secure the sensor in place, but also to remove the stresses from the sensor leads. In addition, these stresses can be high if the hose is not properly secured to the sensor port. Screws, rivets, push-pins, and clips are a few types of hardware that can be used. Refer to Figure 2.

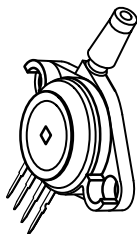

Single Side Port

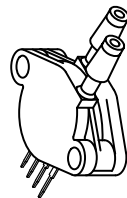

Differential Port

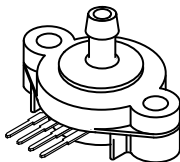

Axial Port



Stovepipe Port

Figure 1. MPX Pressure Sensors with Ported Packages

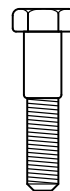

Screw

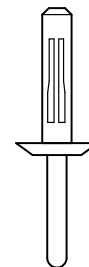

Rivet

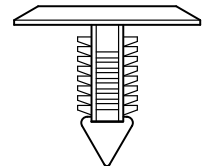

Push-Pin

Figure 2. Mounting Hardware

- NOTES:
 1. DIMENSIONING AND TOLERANCING PER ANSI Y14.5M, 1982.
 2. CONTROLLING DIMENSION: INCH.

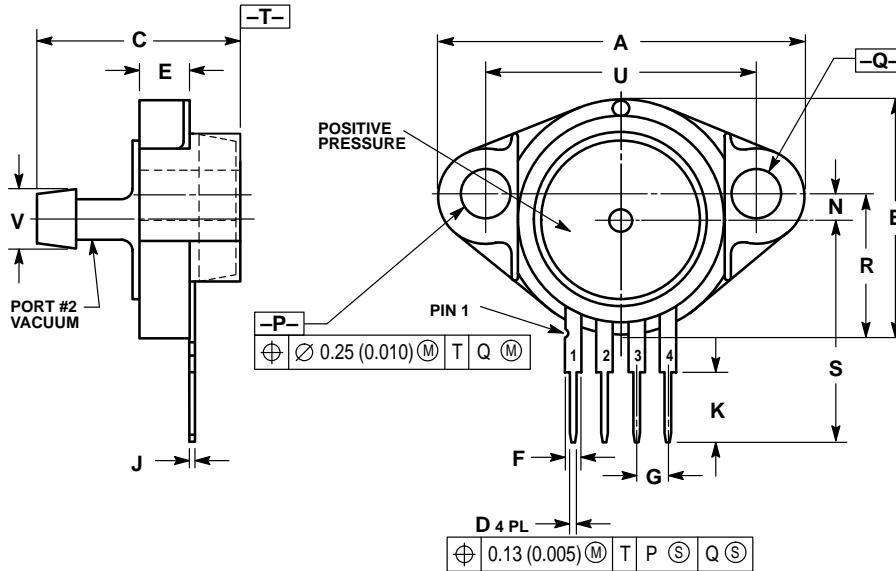

DIM	INCHES		MILLIMETERS	
	MIN	MAX	MIN	MAX
A	1.100	1.200	27.94	30.48
B	0.740	0.760	18.80	19.30
C	0.635	0.650	16.13	16.51
D	0.016	0.020	0.41	0.50
E	0.160	0.180	4.06	4.57
F	0.048	0.052	1.22	1.32
G	0.100 BSC		2.54 BSC	
J	0.014	0.016	0.36	0.40
K	0.230 REF		5.84 REF	
N	0.070	0.080	1.78	2.03
P	0.150	0.160	3.81	4.06
Q	0.150	0.160	3.81	4.06
R	0.445	0.460	11.30	11.68
S	0.685	0.715	17.40	18.16
U	0.840	0.860	21.33	21.84
V	0.185	0.195	4.69	4.95

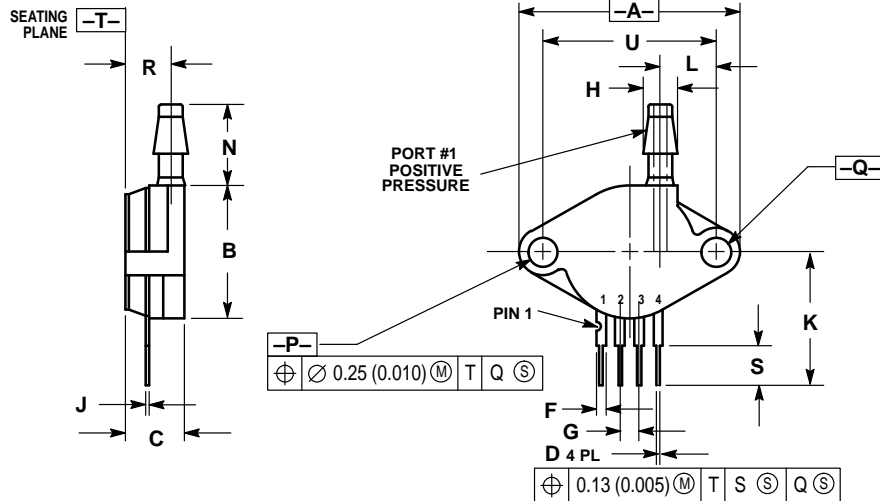

- NOTES:
 1. DIMENSIONING AND TOLERANCING PER ANSI Y14.5, 1982.
 2. CONTROLLING DIMENSION: INCH.

DIM	INCHES		MILLIMETERS	
	MIN	MAX	MIN	MAX
A	1.140	1.180	28.95	29.97
B	0.685	0.751	17.39	18.16
C	0.305	0.321	7.74	8.15
D	0.016	0.020	0.40	0.50
F	0.048	0.052	1.21	1.32
G	0.100 BSC		2.54 BSC	
H	0.182	0.194	4.62	4.92
J	0.014	0.016	0.35	0.40
K	0.685	0.715	17.39	18.16
L	0.290	0.300	7.34	7.62
N	0.420	0.440	10.67	11.12
P	0.153	0.158	3.88	4.01
Q	0.153	0.158	3.88	4.01
R	0.231	0.250	5.86	6.35
S	0.230 REF		5.84 REF	
U	0.910 BSC		23.11 BSC	

Figure 3. Case Outline Drawings
 Top: Case 371D-02, Issue B
 Bottom: Case 350-03, Issue H

To mount any of the devices except Case 371-05/06 and 867E) to a flat surface such as a circuit board, the spacing and diameter for the mounting holes should be made according to Figure 3.

Mounting Screws

Mounting screws are recommended for making a very secure, yet removable connection. The screws can be either metal or nylon, depending on the application. The holes are 0.155" diameter which fits a #6 machine screw. The screw can be threaded directly into the base mounting surface or go through the base and use a flat washer and nut (on a circuit board) to secure to the device.

MOUNTING TORQUE

The torque specifications are very important. The sensor package should not be over tightened because it can crack, causing the sensor to leak. The recommended torque specification for the sensor packages are as follows:

Port Style	Torque Range
Single side port:	
port side down	3-4 in-lb
port side up	6-7 in-lb
Differential port (dual port)	9-10 in-lb
Axial side port	9-10 in-lb

The torque range is based on installation at room temperature. Since the sensor thermoplastic material has a higher TCE (temperature coefficient of expansion) than common metals, the torque will increase as temperature increases. Therefore, if the device will be subjected to very low temperatures, the torque may need to be increased slightly. If a precision torque wrench is not available, these torques all work out to be roughly 1/2 of a turn past "finger tight" (contact) at room temperature.

Tightening beyond these recommendations may damage the package, or affect the performance of the device.

Nylon Screws

Motorola recommends the use of #6–32 nylon screws as a hardware option. However, they should not be torqued excessively. The nylon screw will twist and deform under higher than recommended torque. These screws should be used with a nylon nut.

Rivets

Rivets are excellent fasteners which are strong and very inexpensive. However, they are a permanent connection. Plastic rivets are recommended because metal rivets may damage the plastic package. When selecting a rivet size, the most important dimension, besides diameter, is the grip range. The grip range is the combined thickness of the sensor package and the thickness of the mounting surface. Package thicknesses are listed below.

Port Style	Thickness, a	Grip Range = a + b
Single side port	0.321" (8.15 mm)	
Dual side port	0.420" (10.66 mm)	
Axial side port	0.321" (8.15 mm)	
Stovepipe port	(Does not apply)	

Push-Pins

Plastic push pins or ITW FasTex "Christmas Tree" pins are an excellent way to make a low cost and easily removable connection. However, these fasteners should not be used for permanent connections. Remember, the fastener should take all of the static and dynamic loads off the sensor leads. This type of fastener does not do this completely.

HOSE APPLICATIONS

By using a hose, a sensor can be located in a convenient place away from the actual sensing location which could be a hazardous and difficult area to reach. There are many types of hoses on the market. They have different wall thicknesses, working pressures, working temperatures, material compositions, and media compatibilities. All of the hoses referenced here are 1/8" inside diameter and 1/16" wall thickness, which produces a 1/4" outside diameter. Since all the port hose barbs are 1/8", they require 1/8" inside diameter hose. The intent is for use in air only and any questions about hoses for your specific application should be directed to the hose manufacturer. Four main types of hose are available:

- Vinyl
- Tygon
- Urethane
- Nylon

Vinyl hose is inexpensive and is best in applications with pressures under 50 psig and at room temperature. It is flexible and durable and should not crack or deteriorate with age. This type of hose should be used with a hose clamp such as those

listed later in this application note. Two brands of vinyl hose are:

Hose	Wall Thickness	Max. Press. @ 70°F (24°C)	Max. Temp. (°F)/(°C)
Clippard #3814-1	1/16"	105	100/(38)
Herco Clear #0500-037	1/16"	54	180/(82)

Tygon tubing is slightly more expensive than vinyl, but it is the most common brand, and it is also very flexible. It also is recommended for use at room temperature and applications below 50 psig. This tubing is also recommended for applications where the hose may be removed and reattached several times. This tubing should also be used with a hose clamp.

Tubing	Wall Thickness	Max. Press. @ 73°F (25°C)	Max. Temp. (°F)/(°C)
Tygon B-44-3	1/16"	62	165/(74)

Urethane tubing is the most expensive of the four types described herein. It can be used at higher pressures (up to 100 psig) and temperatures up to 100°F (38°C). It is flexible, although its flexibility is not as good as vinyl or Tygon. Urethane tubing is very strong and it is not necessary to use a hose clamp, although it is recommended.

Two brands of urethane hose are:

Hose	Wall Thickness	Max. Press. @ 70°F (24°C)	Max. Temp. (°F)/(°C)
Clippard #3814-6	1/16"	105	120/(49)
Herco Clear #0585-037	1/16"	105	225/(107)

Nylon tubing does not work well with Motorola's sensors. It is typically used in high pressure applications with metal fittings (such as compressed air).

HOSE CLAMPS

Hose clamps should be employed for use with all hoses listed above. They provide a strong connection with the sensor which prevents the hose from working itself off, and also reduces the chance of leakage. There are many types of hose clamps that can be used with the ported sensors. Here are some of the most common hose clamps used with hoses.

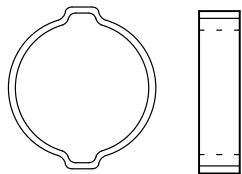

Crimp-on Clamp

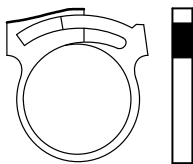

Nylon Snap

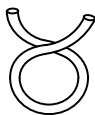

Spring Wire

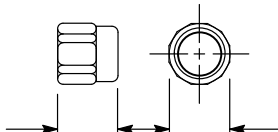

Screw-on

The two clamps most recommended by Motorola are the crimp-on clamp and the screw-on, Clippard reusable clamp. The crimp-on type clamp is offered from both Ryan Herco (#0929-007) and Clippard (#5000-2). Once crimped in place, it provides a very secure hold, but it is not easily removed and is not reusable. The Clippard, reusable hose clamp is a brass, self-threading clamp, which provides an equally strong grip as the crimp-on type just described. The drawback is the reusable clamp is considerably more expensive. The nylon snap is also reusable, however the size options do not match the necessary outside diameter. The spring wire clamp, common in the automotive industry, and known for its very low cost and ease of use, also has a size matching problem. Custom fit spring wire clamps may provide some cost savings in particular applications.

Figure 4. Hose Clamps

SUPPLIER LIST

Hoses

Norton-Performance Plastics
 Worldwide Headquarters
 150 Dey Road, Wayne, NJ 07470-4599 USA
 (201) 596-4700
 Telex: 710-988-5834
 USA
 P.O. Box 3660, Akron, OH 44309-3660
 USA
 (216) 798-9240
 FAX: (216) 798-0358

Clippard Instrument Laboratory, Inc.
 7390 Colerain Rd.
 Cincinnati, Ohio 45239, USA
 (513) 521-4261
 FAX: (513) 521-4464

Ryan Herco Products Corporation
 P.O. Box 588
 Burbank, CA 91503
 1-800-423-2589
 FAX: (818) 842-4488

Spring Wire Clamps

RotorClip, Inc.
 187 Davidson Avenue
 Somerset, NJ 08875-0461
 1-800-631-5857 Ext. 255

Rivets and Push-Pins

ITW FasTex
 195 Algonquin Road
 Des Plaines, IL 60016
 (708) 299-2222
 FAX: (708) 390-8727

Bolts

Quality Screw and Nut Company
 1331 Jarvis Avenue
 Elk Grove Village, IL 60007
 (312) 593-1600

Crimp-on and Nylon Clamps

Ryan Herco Products Corporation
 P.O. Box 588
 Burbank, CA 91503
 1-800-423-2589
 FAX: (818) 842-4488

Crimp-on and Screw-on Clamps

Clippard Instrument Laboratory, Inc.
 7390 Colerain Rd.
 Cincinnati, Ohio 45239, USA
 (513) 521-4261
 FAX: (513) 521-4464



Motorola reserves the right to make changes without further notice to any products herein. Motorola makes no warranty, representation or guarantee regarding the suitability of its products for any particular purpose, nor does Motorola assume any liability arising out of the application or use of any product or circuit, and specifically disclaims any and all liability, including without limitation consequential or incidental damages. "Typical" parameters which may be provided in Motorola data sheets and/or specifications can and do vary in different applications and actual performance may vary over time. All operating parameters, including "Typicals" must be validated for each customer application by customer's technical experts. Motorola does not convey any license under its patent rights nor the rights of others. Motorola products are not designed, intended, or authorized for use as components in systems intended for surgical implant into the body, or other applications intended to support or sustain life, or for any other application in which the failure of the Motorola product could create a situation where personal injury or death may occur. Should Buyer purchase or use Motorola products for any such unintended or unauthorized application, Buyer shall indemnify and hold Motorola and its officers, employees, subsidiaries, affiliates, and distributors harmless against all claims, costs, damages, and expenses, and reasonable attorney fees arising out of, directly or indirectly, any claim of personal injury or death associated with such unintended or unauthorized use, even if such claim alleges that Motorola was negligent regarding the design or manufacture of the part. Motorola and  are registered trademarks of Motorola, Inc. Motorola, Inc. is an Equal Opportunity/Affirmative Action Employer.

Mfax is a trademark of Motorola, Inc.

How to reach us:**USA/EUROPE/Locations Not Listed:** Motorola Literature Distribution;
P.O. Box 5405, Denver, Colorado 80217. 303-675-2140 or 1-800-441-2447**JAPAN:** Nippon Motorola Ltd.; Tatsumi-SPD-JLDC, 6F Seibu-Butsuryu-Center,
3-14-2 Tatsumi Koto-Ku, Tokyo 135, Japan. 81-3-3521-8315**Mfax™:** RMFAX0@email.sps.mot.com – TOUCHTONE 602-244-6609
– US & Canada ONLY 1-800-774-1848**ASIA/PACIFIC:** Motorola Semiconductors H.K. Ltd.; 8B Tai Ping Industrial Park,
51 Ting Kok Road, Tai Po, N.T., Hong Kong. 852-26629298**INTERNET:** <http://motorola.com/sps>**MOTOROLA**

**For More Information On This Product,
Go to: www.freescale.com**

AN1513/D