

Using Low Power modes on Kinetis family

by: Daniel Martinez, César Manzanarez
Guadalajara, México

1 Introduction

The power consumption of devices and the implications around designing for low power are common topics currently.

Freescale offers solutions with energy efficient products that can help you achieve the power consumption needed for your application.

This application note will guide you to achieve the available power consumption modes on the Kinetis family processors.

It is important to indicate that this application note is based on the Kinetis 50 MHz devices, so some low power modes might not be available in all the Kinetis family of devices this is indicated in the corresponding chapter.

Contents

1	Introduction	1
2	Low power overview and best practices	2
3	System Clock Generation	2
	3.1 Functionality of the system clock in low power modes	4
4	Description and usage of low power modes	5
	4.1 Run mode	5
	4.2 Wait mode	6
	4.3 Stop mode	6
	4.4 VLPR (Very Low Power Run)	7
	4.5 VLPW (Very Low Power Wait)	8
	4.6 VLPS (Very Low Power Stop)	9
	4.7 LLS (Low Leakage Stop)	9
	4.8 VLLS3 (Very Low Leakage Stop3)	10
	4.9 VLLS2 (Very Slow Leakage Stop2)	11
	4.10 VLLS1 (Very Low Leakage Stop1)	12
	4.11 VLLS0 (Very Low Leakage Stop0)	13
5	Module operation in Low Power modes	15
6	Allowed power mode transitions	18
7	Demo to enter power modes	19
	7.1 Flash programming and debugging settings	20
	7.2 Steps to run the demo	38
8	Conclusion	42
9	References	42

2 Low power overview and best practices

There are many reasons why a designer of an embedded system is increasingly striving to stay within tight power consumption budgets.

One reason is money, having a portable device with a poor battery life can be the cause of losing in the market against more power efficient competitors.

There are other applications in which money goes to second term, like medical devices that are implanted in a patient's body. This device needs to run for years on battery life, replacing the battery means taking the patient to surgery, so in this scenario an efficient power solution is critical.

A low power design should take into consideration the tradeoff between power consumption and performance, and use every possible feature provided by the device to accomplish the best results.

Both software and hardware designers should be involved in a power efficient design, and estimate the application's power needs early in the planning stage to avoid any late redesigns.

Tips and tricks to consider when designing for low power:

- Set the pins to a known state:
For the Kinetis family it is recommended to leave unused pines floating and configure them as disabled.
- Select and configure the desired clock mode.
Keep in mind that higher core frequency means higher power consumption.
- Higher operating temperature increases power consumption.
- Disable clock to all unused modules
- Clock monitor output and debug enabled will increase power consumption and must be avoided.

In the following chapters we will study in detail each of the modules involved in the microcontroller operation and its correlation with the low power modes available in the Kinetis family.

3 System Clock Generation

The Kinetis family features a Multipurpose Clock Generator (MCG) module capable of using an external (System oscillator, RTC oscillator) or an internal source to generate the system clock.

In [Figure 1](#) we can view the dependencies among these modules:

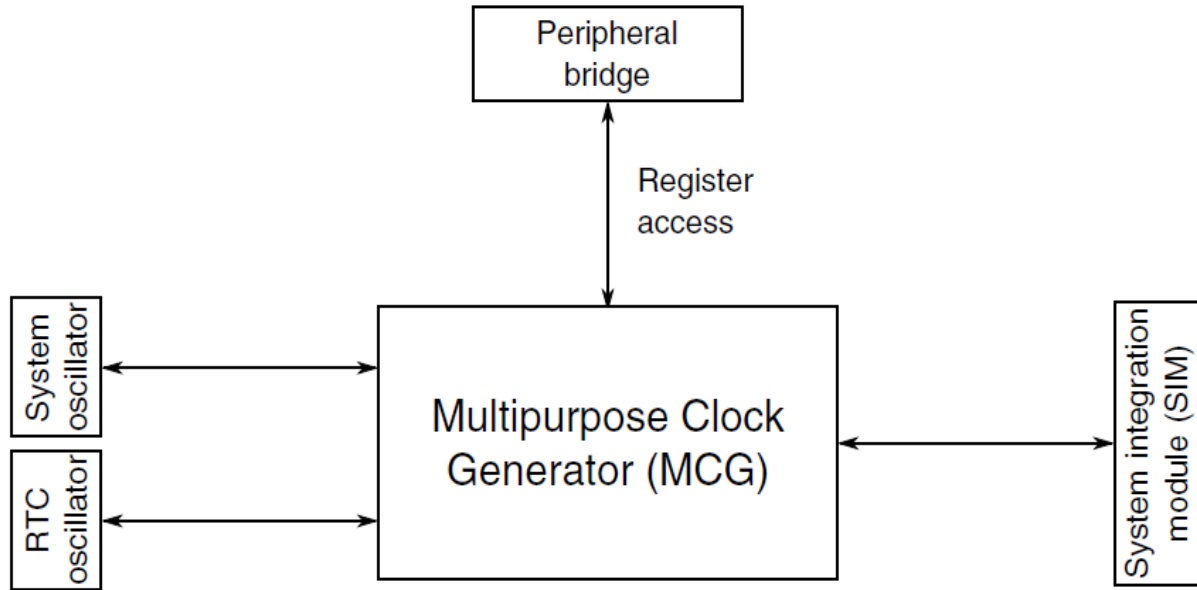

Figure 1. MCG Configuration

The system oscillator and the RTC oscillator are the external sources that you can use to feed the MCG.

The OSC module is a crystal oscillator. The module, in conjunction with an external crystal or resonator, generates a reference clock for the MCU.

The RTC oscillator module provides the clock source for the RTC. The RTC oscillator module, in conjunction with an external crystal, generates a reference clock for the RTC.

In addition you have the option of selecting between two internal reference clocks as the input source for the MCG as follows:

- Slow IRC (32 kHz) and Fast IRC (4 MHz)

These internal clocks are part of the MCG module.

The MCG module controls which clock source is used to derive the system clocks. The clock generation logic divides the selected clock source into a variety of clock domains, including the clocks for the system bus masters, system bus slaves, and flash memory.

In summary there are 4 input clock sources that can be used as the clock generator for the microcontroller, you should select the source depending on the requirements of your application.

Module dependencies:

- All modules are dependent on the MCG for one or more of their clocks
- Oscillator module relies on the MCG for the control signals.
- The oscillator must be set up correctly, from within the MCG, before it is used
- System clock dividers must be setup before increasing the MCGOUT frequency to ensure the maximum clock rate is not exceeded.

System Clock Generation

- MCG is powered in all low power modes except very low leakage stop modes.
- Crystal oscillator pins are XTAL and EXTAL by default out of reset.
- There is no clock gating associated with the MCG module itself.

There are in total 9 different modes of operation for the MCG: FEI, FEE, FBI, FBE, PBE, PEE, BLPI, BLPE, and Stop.

In the following chapter you can view important details of the system clock setup in the different low power modes.

For more details in each specific module you can refer to the device Reference Manual.

3.1 Functionality of the system clock in low power modes

- STOP - Normal Stop Mode
 - Can enter STOP from any MCG mode
 - Can optionally keep the PLL enabled but the output will be gated off - C5[PLLSTEN]
 - Can optionally keep the internal reference clock enabled – C1[IREFSTEN]
 - Can optionally keep the external reference clock enabled – OSC_CR[EREFSTEN]
 - Will exit STOP in the same MCG mode when STOP was entered
 - The exception to this if STOP is entered when in PEE mode and PLLSTEN=0, in this case the MCG will be in PBE mode when STOP is exited
- VLPR – Very Low Power Run Mode
 - Can enter VLPR from BLPI mode with the fast IRC selected.
 - Can enter VLPR from BLPE mode if the external clock is 4 MHz max.
 - Will exit VLPR in the same MCG mode when VLPR was entered (BLPI or BLPE)
- VLPW – Very Low Power Wait Mode
 - Can enter VLPW from BLPI mode with the fast IRC selected.
 - Can enter VLPW from BLPE mode if the external clock is 4 MHz max.
 - Will exit VLPW in the same MCG mode when VLPW was entered (BLPI or BLPE)
 - Can optionally keep the external reference clock enabled (4 MHz max.)
- VLPS – Very Low Power Stop
 - Can enter VLPS from any MCG mode
 - Can optionally keep the external reference clock enabled (4 MHz max.)
 - MCG is static with no clocks active (IREFSTEN and PLLSTEN have no effect)
 - Will exit VLPS in the same MCG mode when VLPS was entered
 - The exception to this if VLPS is entered when in PEE mode, in this case the MCG will be in PBE mode when VLPS is exited
- LLS – Low Leakage Stop
 - Can enter LLS from any MCG mode

- Can optionally keep the external reference clock enabled in low range and low power oscillator mode (32 kHz)
- MCG is static with no clocks active (IREFSTEN and PLLSTEN have no effect)
- Will exit LLS in the same MCG mode when LLS was entered
 - The exception to this if LLS is entered when in PEE mode, in this case the MCG will be in PBE mode when LLS is exited
- VLLS0/1/2/3 – Very Low Leakage Stop
 - Can enter VLLSx from any MCG mode
 - MCG is off, no clocks active, register states are not maintained
 - Will exit in FEI mode (reset state)
 - Can optionally keep the external reference clock enabled in low range and low power oscillator mode (32 kHz). Must reconfigure the oscillator before clearing the ACKISO bit.

4 Description and usage of low power modes

The operating modes described in this chapter apply for the Kinetis family devices.

The available modes of operation are the following:

- Run
- Wait
- Stop
- VLPR (Very Low Power Run)
- VLPW (Very Low Power Wait)
- VLPS (Very Low Power Stop)
- LLS (Low Leakage Stop)
- VLLS3 (Very Low Leakage Stop3)
- VLLS2 (Very Low Leakage Stop2)
- VLLS1 (Very Low Leakage Stop1)
- VLLS0 (Very Low Leakage Stop0) ¹
- BAT (Backup battery only)

In this chapter we will discuss details about all modes of operation relevant to the topic of this application note. That is all modes except the Run and BAT.

NOTE

For a full description of the operating modes refer to the device reference manual, search for chapter “Power modes”.

1. This mode of operation is **present only in the 50 MHz devices**. It has two modes of operation: Power On reset detect circuit enabled or disabled.

4.1 Run mode

This is the default mode out of reset.

Allows maximum performance of the chip.

Mode of operation details:

- Selected after any Reset
- On chip voltage regulator is on, full capability
- Stack pointer (SP), Program Counter (PC) and link register are set
- ARM processor exits reset and reads the start SP
- ARM processor reads the start PC from vector table
- Reduce power by clearing clock gating bits in SCGCx

4.2 Wait mode

Allows peripherals to function while the core is in sleep mode, reducing power.

NVIC remains sensitive to interrupts; peripherals continue to be clocked.

Mode of operation details:

- ARM core enters Sleep Mode
- ARM core is clock gated (HCLK = OFF)
- NVIC remains sensitive to interrupts (FCLK = ON)
- Peripherals continue to be clocked
- Reduce power by clearing clock gating bits in SCGCx
- On interrupt the ARM core exits Sleep Mode: Resume processing

Table 1. How to enter Wait mode

From	To	Trigger conditions
Run	Wait	Execute WAIT(); - This means that sleep-now or sleep-on-exit modes entered with SLEEPDEEP clear
Wait	Run	Interrupt or Reset

4.3 Stop mode

Places chip in static state. Lowest power mode that retains all registers while maintaining LVD protection. NVIC is disabled; AWIC is used to wake up from interrupt; peripheral clocks are stopped.

Mode of operation details:

- ARM core enters DeepSleep Mode
- ARM core is clock gated (HCLK = OFF)

- NVIC is disable (FCLK = OFF)
- WIC is used to wake up from interruptions
- Platform and peripheral clock are stopped
- MCG module can be configured to leave reference clocks running
- All SRAM is operating (content retained and I/O states held)

Table 2. How to enter Stop mode

From	To	Trigger Conditions
Run	Stop	Execute STOP(); This means that sleep-now or sleep-on-exit modes entered with SLEEPDEEP set
Stop	Run	Interrupt or Reset – Interrupt goes to ISR (no LLWU)

4.4 VLPR (Very Low Power Run)

On-chip voltage regulator is in a low power mode that supplies only enough power to run the chip at a reduced frequency. Reduced frequency Flash access mode (1 MHz); LVD off; internal oscillator provides a low power 4 MHz source for the core, the bus and the peripheral clocks.

Mode of operation details:

- On chip voltage regulator is in a mode that supplies only enough power to run the MCU in a reduced frequency
- Core and Bus clock limited to 4Mhz
- Flash frequency limited to 1Mhz
- Reduce power by clearing clock gating bits in SCGCx
- Flash programming and erasing is not allowed
- FlexMemory (EEPROM) programming is not allowed
- Clock Monitor:
 - CME0 and CME1 should also be set to a logic 0 before entering VLPR or VLPW power modes if the MCG is in BLPE mode.

Table 3. How to enter VLPR mode

From	To	Trigger Conditions
Run	VLPR	Reduce system bus and core frequency to 2 MHz or less Flash access frequency limited to 1 MHz, AVLP = 1 Set RUNM = 10 Note: Poll VLPRS bit before executing VLPR specific code (You can wait ~5 μ s instead of waiting for VLPRS)
VLPR	Run	Set RUNM = 00 or Interrupt with LPWUI = 1 or Reset Note: Poll REGONS bit before increasing frequency.

4.5 VLPW (Very Low Power Wait)

Same as VLPR but with the core in sleep mode to further reduce power; NVIC remains sensitive to interrupts (FCLK = ON). On-chip voltage regulator is in a low power mode that supplies only enough power to run the chip at a reduced frequency.

Mode of operation details:

- ARM core enters Sleep Mode
- ARM core is clock gated (HCLK = OFF)
- NVIC remains sensitive to interrupts (FCLK = ON)
- On chip voltage regulator is in a mode that supplies only enough power to run the MCU in a reduced frequency
- System and Bus clock limited to 4Mhz
- Reduce power by clearing clock gating bits in SCGCx
- Clock Monitor:
 - CME0 and CME1 should also be set to a logic 0 before entering VLPR or VLPW power modes if the MCG is in BLPE mode.

Table 4. How to enter VLPW mode

From	To	Trigger Conditions
VLPR	VLPW	Execute WAIT();
VLPW	VLPR	Interrupt with LPWUI = 0
VLPW	RUN	Interrupt with LPWUI = 1 or Reset

4.6 VLPS (Very Low Power Stop)

Places chip in static state with LVD operation off. Lowest power mode with ADC and pin interrupts functional. Peripheral clocks are stopped, but LPTimer, RTC, CMP, TSI can be used. NVIC is disabled (FCLK =OFF), AWIC is used to wake up from interrupt.

On-chip voltage regulator is in a low power mode that supplies only enough power to run the chip at a reduced frequency. All SRAM is operating (content retained and I/O states held).

Mode of operation details:

- ARM core enters DeepSleep Mode
- ARM core is clock gated (HCLK = OFF)
- NVIC is disable (FCLK = OFF)
- WIC is used to wake up from interruptions
- Platform and peripheral clock are stopped
- MCG module can be configured to leave reference clocks running
- On chip voltage regulator is in a mode that supplies only enough power to run the MCU in a reduced frequency
- All SRAM is operating (content retained and I/O states held)

Table 5. How to enter VLPS mode

From	To	Trigger Conditions
VLPR	VLPS	STOPM = 000 or 010, execute STOP();
VLPS	VLPR	Interrupt with LPWUI = 0
RUN	VLPS	AVLP=1, STOPM =010, execute STOP();
VLPS	RUN	Interrupt with LPWUI= 1 or Reset

4.7 LLS (Low Leakage Stop)

State retention power mode. Most peripherals are in state retention mode (with clocks stopped), but LLWU, LPTimer, RTC, CMP, TSI can be used. NVIC is disabled, LLWU is used to wake up.

NOTE

The LLWU interrupt must not be masked by the interrupt controller to avoid a scenario where the system does not fully exit stop mode on an LLS recovery.

All SRAM is operating (content retained and I/O states held).

Mode of operation details:

- ARM core enters Deep Sleep Mode
- ARM core is clock gated (HCLK = OFF)
- NVIC is disable (FCLK = OFF)
- LLWU is used to wake up from interruptions
- Platform and peripheral clock are stopped
- MCG module can be configured to leave reference clocks running
- On chip voltage regulator is in a mode that supplies only enough power to run the MCU in a reduced frequency
- All SRAM is operating (content retained and I/O states held)
- Most of peripherals are in state retention mode (cannot operate)

Table 6. How to enter LLS mode

From	To	Trigger Conditions
Run	LLS	Set ALLS in PMPROT, PMCTRL_STOPM = 011, Execute STOP();
LLS	Run	Wakeup from enabled LLWU pin or module source or Reset pin
VLPR	LLS	Set ALLS in PMPROT, PMCTRL_STOPM = 011, Execute STOP();

4.8 VLLS3 (Very Low Leakage Stop3)

Most peripherals are disabled (with clocks stopped), but LLWU, LPTimer, RTC, CMP, TSI can be used. NVIC is disabled, LLWU is used to wake up. SRAM_U and SRAM_L remain powered on (content retained and I/O states held).

Mode of operation details:

- ARM core enters SleepDeep Mode
- ARM core is clock gated (HCLK = OFF)
- NVIC is disable (FCLK = OFF)
- LLWU should configure by user to enable the desire wake up source
- Platform and peripheral clock are stopped
- MCG module can be configured to leave reference clocks running

- On chip voltage regulator is in a mode that supplies only enough power to run the MCU in a reduced frequency
- All SRAM is operating (content retained and I/O states held)
- Most modules are disabled

Table 7. How to enter VLLS3 mode

From	To	Trigger Conditions
Run	VLLS (3,2,1,0)	Set AVLLSx in PMPROT, PMCTRL_STOPM = 100 VLLSM = 011 for VLLS3, 010 for VLLS2, 001 for VLLS1, 000 for VLLS0 Note: For VLLS0 you must set or clear PORPO to disable or enable (respectively) the POR detect circuit. Execute STOP();
VLLS (3,2,1,0)	Run	Wakeup from enabled LLWU input source or Reset. All wakeup goes through Reset sequence. Check SRS for source of wakeup. Check VLLSM for mode
VLPR	VLLS(3,2,1,0)	Set AVLLSx in PMPROT, PMCTRL_STOPM = 100 VLLSM = 011 for VLLS3, 010 =for VLLS2, 001 for VLLS1, 000 for VLLS0 Note: For VLLS0 you must set or clear PORPO to disable or enable (respectively) the POR detect circuit. Execute STOP();

4.9 VLLS2 (Very Slow Leakage Stop2)

Most peripherals are disabled (with clocks stopped), but LLWU, LPTimer, RTC, CMP, TSI can be used. NVIC is disabled; LLWU is used to wake up.

SRAM_L is powered off. A portion of SRAM_U remains powered on (content retained and I/O states held).

Mode of operation details:

- ARM core enters SleepDeep Mode
- ARM core is clock gated (HCLK = OFF)
- NVIC is disable (FCLK = OFF)
- LLWU should configure by user to enable the desire wake up source
- Platform and peripheral clock are stopped

Description and usage of low power modes

- MCG module can be configured to leave reference clocks running
- On chip voltage regulator is in a mode that supplies only enough power to run the MCU in a reduced frequency
- Only partial SRAM is operating (content retained and I/O state held)
- Most modules are disabled

Table 8. How to enter VLLS2 mode

From	To	Trigger Conditions
Run	VLLS (3,2,1,0)	Set AVLLSx in PMPROT, PMCTRL_STOPM = 100 VLLSM = 011 for VLLS3, 010 for VLLS2, 001 for VLLS1, 000 for VLLS0 Note: For VLLS0 you must set or clear PORPO to disable or enable (respectively) the POR detect circuit. Execute STOP();
VLLS(3,2,1,0)	Run	Wakeup from enabled LLWU input source or Reset. All wakeup goes through Reset sequence. Check SRS for source of wakeup. Check VLLSM for mode
VLPR	VLLS(3,2,1,0)	Set AVLLSx in PMPROT, PMCTRL_STOPM = 100 VLLSM = 011 for VLLS3, 010 for VLLS2, 001 for VLLS1, 000 for VLLS0 Note: For VLLS0 you must set or clear PORPO to disable or enable (respectively) the POR detect circuit. Execute STOP();

4.10 VLLS1 (Very Low Leakage Stop1)

Most peripherals are disabled (with clocks stopped), but LLWU, LPTimer, RTC, CMP, TSI can be used. NVIC is disabled; LLWU is used to wake up.

All of SRAM_U and SRAM_L are powered off. The 32-byte system register file and the 32-byte VBAT register file remain powered for customer-critical data.

Mode of operation details:

- ARM core enters SleepDeep Mode
- ARM core is clock gated (HCLK = OFF)
- NVIC is disable (FCLK = OFF)
- LLWU should configure by user to enable the desire wake up source

- Platform and peripheral clock are stopped
- MCG module can be configured to leave reference clocks running
- On chip voltage regulator is in a mode that supplies only enough power to run the MCU in a reduced frequency
- All SRAM is powered down, only 32 byte register content retained and I/O states held
- Most modules are disabled

Table 9. How to enter VLLS1 mode

From	To	Trigger Conditions
Run	VLLS (3,2,1,0)	Set AVLLSx in PMPROT, PMCTRL_STOPM = 100 VLLSM = 011 for VLLS3, 010 for VLLS2, 001 for VLLS1, 000 for VLLS0 Note: For VLLS0 you must set or clear PORPO to disable or enable (respectively) the POR detect circuit. Execute STOP();
VLLS(3,2,1,0)	Run	Wakeup from enabled LLWU input source or Reset. All wakeup goes through Reset sequence. Check SRS for source of wakeup. Check VLLSM for mode.
VLPR	VLLS (3,2,1,0)	Set AVLLSx in PMPROT, PMCTRL_STOPM = 100 VLLSM = 011 for VLLS3, 010 for VLLS2, 001 for VLLS1, 000 for VLLS0 Note: For VLLS0 you must set or clear PORPO to disable or enable (respectively) the POR detect circuit. Execute STOP();

4.11 VLLS0 (Very Low Leakage Stop0)

LLWU, RTC. All SRAM powered off.

Mode of operation details:

- ARM core enters SleepDeep Mode
- ARM core is clock gated (HCLK = OFF)
- NVIC is disabled (FCLK = OFF)
- LLWU should configure by user to enable the desire wake up source
- Platform and peripheral clocks are stopped

Module operation in Low Power modes

- MCG module can be configured to leave reference clocks running
- On chip voltage regulator is in a mode that supplies only enough power to run the MCU in a reduced frequency
- All SRAM powered off.
- Most modules are disabled except LLWU and RTC

Table 10. How to enter VLLS0 mode

From	To	Trigger Conditions
Run	VLLS (3,2,1,0)	Set AVLLSx in PMPROT, PMCTRL_STOPM = 100 VLLSM = 011 for VLLS3, 010 for VLLS2, 001 for VLLS1, 000 for VLLS0 Note: For VLLS0 you must set or clear PORPO to disable or enable (respectively) the POR detect circuit. Execute STOP();
VLLS (3,2,1,0)	Run	Wakeup from enabled LLWU input source or Reset. All wakeup goes through Reset sequence. Check SRS for source of wakeup. Check VLLSM for mode.
VLPR	VLLS (3,2,1,0)	Set AVLLSx in PMPROT, PMCTRL_STOPM = 100 VLLSM = 011 for VLLS3, 010 for VLLS2, 001 for VLLS1, 000 for VLLS0 Note: For VLLS0 you must set or clear PORPO to disable or enable (respectively) the POR detect circuit. Execute STOP();

5 Module operation in Low Power modes

In this chapter we can view the microcontroller's module status among the different power modes.

In order to choose the most proper low power mode for your application you must first make a list of the modules that need to be enabled.

The following table is useful to decide what low power mode your application should enter based on the modules that you require to be enabled.

Meaning of the terms used in the table:

- FF: Full functionality

- Static: Module register states and associated memories are retained
- Powered: Memory is powered to retain contents
- Low power: Flash has a low power state that retains configuration registers to support faster wakeup
- Off: Modules are powered off; module is in reset state upon wakeup
- Wakeup: Modules can serve as a wakeup source for the chip

For further details you can refer to the device Reference Manual, chapter “Module Operation in Low Power Modes”.

Modules	Stop	VLPR	VLPW	VLPS	LLS	VLLSx
Core modules						
NVIC	static	FF	FF	static	static	OFF
System modules						
Mode Controller	FF	FF	FF	FF	FF	FF
LLWU ¹	static	static	static	static	FF	FF ²
Regulator	ON	low power	low power	low power	low power	low power in VLLS2/3, OFF in VLLS0/1
LVD	ON	disabled	disabled	disabled	disabled	disabled
Brown-out Detection	ON	ON	ON	ON	ON	ON in VLLS1/2/3, optionally disabled in VLLS0 ³
DMA	static	FF	FF	static	static	OFF
Watchdog	FF	FF	FF	FF	static	OFF
EWM	static	FF	static	static	static	OFF
Clocks						
1kHz LPO	ON	ON	ON	ON	ON	ON in VLLS1/2/3, OFF in VLLS0
System oscillator (OSC)	OSCERCLK optional	OSCERCLK max of 4MHz crystal	OSCERCLK max of 4MHz crystal	OSCERCLK max of 4MHz crystal	limited to low range/low power	limited to low range/low power in VLLS1/2/3, OFF in VLLS0
MCG	static - MCGIRCLK optional; PLL optionally on but gated	4 MHz IRC	4 MHz IRC	static - no clock output	static - no clock output	OFF
Core clock	OFF	4 MHz max	OFF	OFF	OFF	OFF
System clock	OFF	4 MHz max	4 MHz max	OFF	OFF	OFF
Bus clock	OFF	4 MHz max	4 MHz max	OFF	OFF	OFF

Module operation in Low Power modes

Memory and memory Interfaces						
Modules	Stop	VLPR	VLPW	VLPS	LLS	VLLSx
Flash	powered	1 MHz max access - no pgm	low power	low power	OFF	OFF
Portion of SRAM_U ⁴	low power	low power	low power	low power	low power	low power in VLLS3,2
Remaining SRAM_U and all of SRAM_L	low power	low power	low power	low power	low power	low power in VLLS3
FlexMemory	low power	low power ⁵	low power	low power	low power	OFF
Register files ⁶	powered	powered	powered	powered	powered	powered
EzPort	disabled	disabled	disabled	disabled	disabled	disabled
Communication Interfaces						
USB FS/LS	static	static	static	static	static	OFF
USB DCD	static	FF	FF	static	static	OFF
USB Voltage Regulator	optional	optional	optional	optional	optional	optional
UART	static, wakeup on edge	125 kbps	125 kbps	static, wakeup on edge	static	OFF
SPI	static	1 Mbps	1 Mbps	static	static	OFF
I ² C	static, address match wakeup	100 kbps	100 kbps	static, address match wakeup	static	OFF
I ² S	FF with external clock ⁷	FF	FF	FF with external clock ⁷	static	OFF
Security						
CRC	static	FF	FF	static	static	OFF

Timers						
FTM	static	FF	FF	static	static	OFF
PIT	static	FF	FF	static	static	OFF
PDB	static	FF	FF	static	static	OFF
LPTMR	FF	FF	FF	FF	FF	FF ⁸
RTC - 32kHz OSC ⁶	FF	FF	FF	FF	FF	FF
CMT	static	FF	FF	static	static	OFF
Analog						
16-bit ADC	ADC internal clock only	FF	FF	ADC internal clock only	static	OFF
CMP ⁹	HS or LS compare	FF	FF	HS or LS compare	LS compare	LS compare in VLLS1/2/3, OFF in VLLS0
6-bit DAC	static	FF	FF	static	static	static
VREF	FF	FF	FF	FF	static	OFF
Human-machine interfaces						
GPIO	wakeup	FF	FF	wakeup	static, pins latched	OFF, pins latched
TSI	wakeup	FF	FF	wakeup	wakeup ¹⁰	wakeup ^{10, 11}

Figure 2. Module operation in low power modes

- Using the LLWU module, the external pins available for this chip do not require the associated peripheral function to be enabled. It only requires the function controlling the pin (GPIO or peripheral) to be configured as an input to allow a transition to occur to the LLWU.
- Since LPO clock source is disabled, filters will be bypassed during VLLS0.
- The VLLSCTRL[PORPO] bit in the SMC module controls this option.
- A 8 KB portion of SRAM_U block is left powered on in low power mode VLLS2.
- FlexRAM enabled as EEPROM is not writable in VLPR and writes are ignored. Read accesses to FlexRAM as EEPROM while in VLPR are allowed. There are no access restrictions for FlexRAM configured as traditional RAM.
- These components remain powered in BAT power mode.
- Use an externally generated bit clock or an externally generated audio master clock (including EXTAL).
- System OSC and LPO clock sources are not available in VLLS0.
- CMP in Stop or VLPS supports high speed or low speed external pin to pin or external pin to DAC compares. CMP in LLS or VLLSx only supports low speed external pin to pin or external pin to DAC compares. Windowed, sampled & filtered modes of operation are not available while in stop, VLPS, LLS, or VLLSx modes.
- TSI wakeup from LLS and VLLSx modes is limited to a single selectable pin.
- System OSC and LPO clock sources are not available in VLLS0.

6 Allowed power mode transitions

This chapter is a brief overview of the allowed power mode transitions. It is important to keep in mind that there are restrictions for switch among all power modes.

The following figure is intended to help you visualize the power mode transitions allowed:

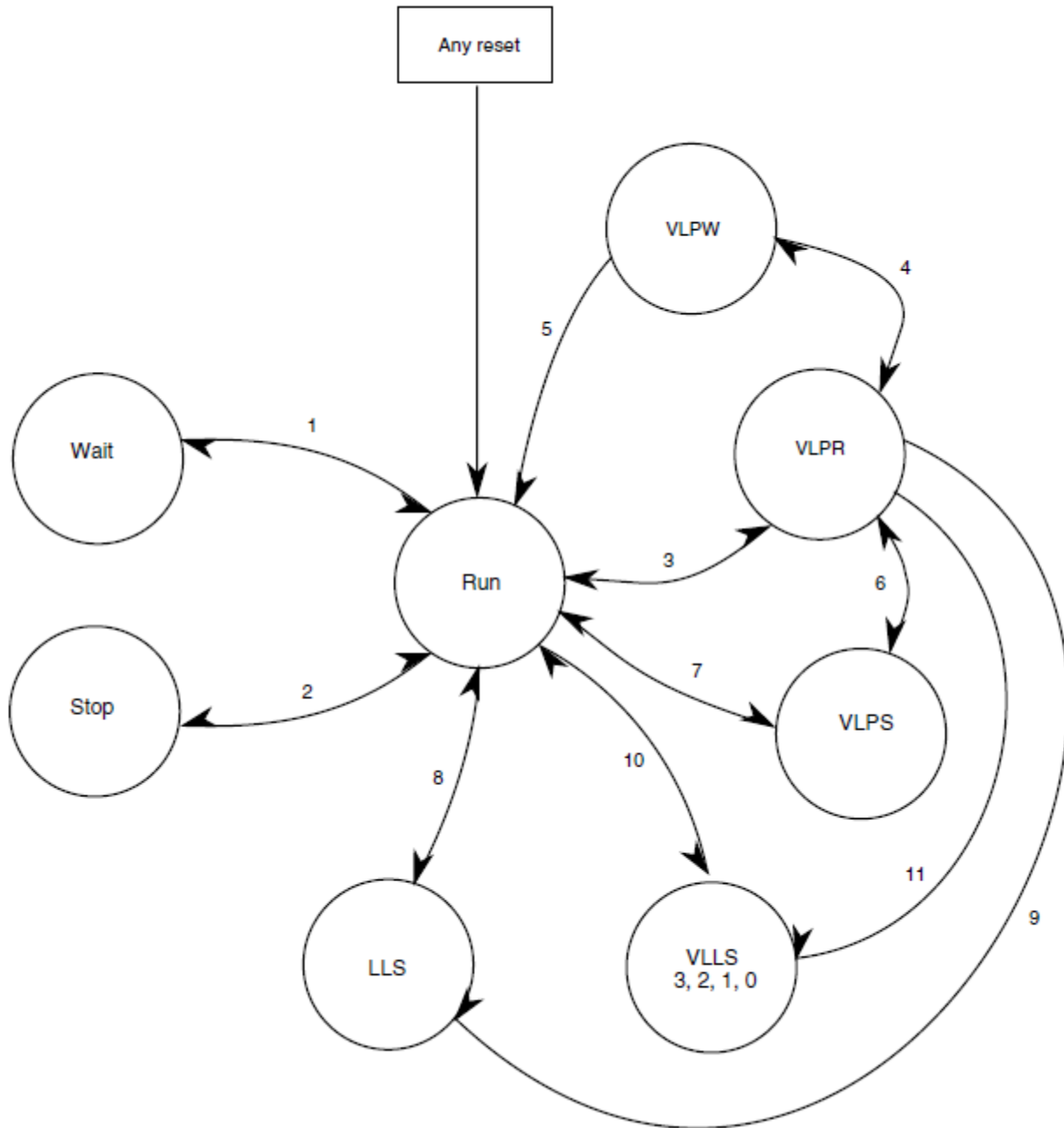

Figure 3. Power mode state transition diagram

As given in the figure above not all mode transitions are allowed, for example if the device is in VLLSx mode and you want to change to Stop mode you must first bring back the device to Run mode and then switch to Stop mode.

Any reset always brings the chip back to the normal run state.

For more details refer to chapter “Power mode transitions” in the device Reference Manual.

7 Demo to enter power modes

In this chapter we will review the necessary conditions to enter the available power modes based on the demo software.

The objective of this demo is to get familiar with the steps needed to enter the available power modes in the Kinetis family of devices.

It is important to clarify that this demo uses only one mode to exit from any operation mode, but there are many ways to exit from any given operation mode as previously explained in this document.

This demo is prepared to run on TWR-K20D50M with a K20DX128 device.

Low Power exit modes:

External pin SW2 has been enabled to wake up via the LLWU from any LLS and VLLSx mode, all wakeup interrupts from these modes must go through LLWU_ISR.

All other modes (non-leakage) can be taken out of low power mode via an interrupt from any of the available port enabled pins, in the case of this demo that is SW2 or SW3.

The following is required:

1. IAR Embedded Workbench for ARM v6.30 or CodeWarrior MCU V10.1 (with *MCU 10.1 Kinetis 50MHz Service Pack* installed)
2. TWR-K20D50M tower board.
3. P&E OSBDM OSJTAG Virtual Serial Toolkit.
You can download it from the following site:
<http://www.pemicro.com/osbdm/index.cfm>
4. Demo project: “low_power_demo”.

This toolkit contains the P&E terminal utility that you need to visualize the menu options via serial over USB.

Before running the demo you need to configure your IDE to the proper settings depending on the programming/debugging interface that you will use.

NOTE

If your preferred debug interface is already installed you can disregard the following section and go directly to chapter 7.2 “Steps to run the demo”.

7.1 Flash programming and debugging settings

In this section we indicate the settings needed to program and debug your application into the Kinetis board using IAR or CodeWarrior IDEs with any of the following debug interfaces: OSJTAG, P&E Multilink, Segger J-Link.

IAR and OSJTAG/P&E Multilink

Flashloader *FlashK20Xxxx* must be used for these connections.

Demo to enter power modes

Unzip **iar_FlashK20Xxxx_8k_ram.zip** located in the demo project zip file and follow the instructions below.

1. Place all of the files in this zip (except “readme.txt”) in your *IAR Systems\Embedded Workbench.6.0_x\arm\config\flashloader\Freescale* folder

NOTE

This applies for the current IAR version IAR 6.30.4, for newer versions these steps will not be necessary.

2. Open your IAR workspace file and select a flash configuration for the project
 - a) Open IAR Embedded Workbench IDE.
 - b) Open the *low_power_demo* workspace.

To do this you can drag and drop the “*low_power_demo.eww*” located on the following path:

{Demo Installation path}\build\iar\low_power_demo

3. In the project options select Debugger->Download.

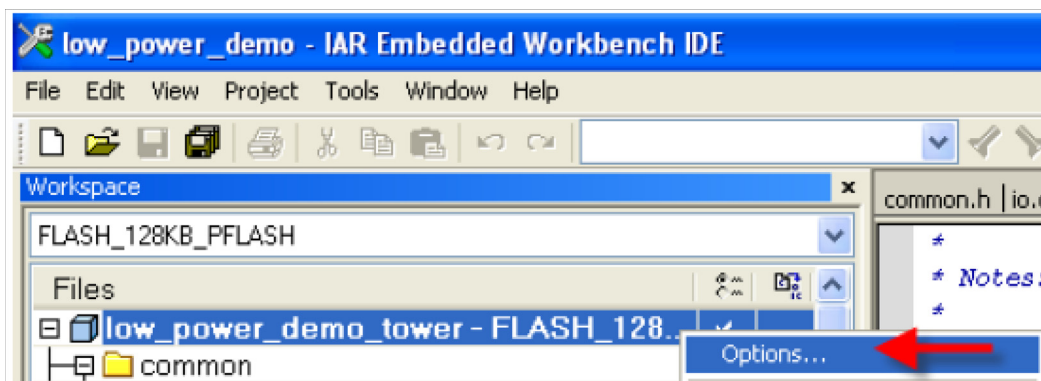

Figure 4.

4. Check the "Use flash loader(s)" box.
5. Check the "Override default .board file box".
6. Provide the path to the FlashK20Xxxx.board file. This will be given as follows:
\$TOOLKIT_DIR\$\config\flashloader\Freescale\FlashK20Xxxx.board.

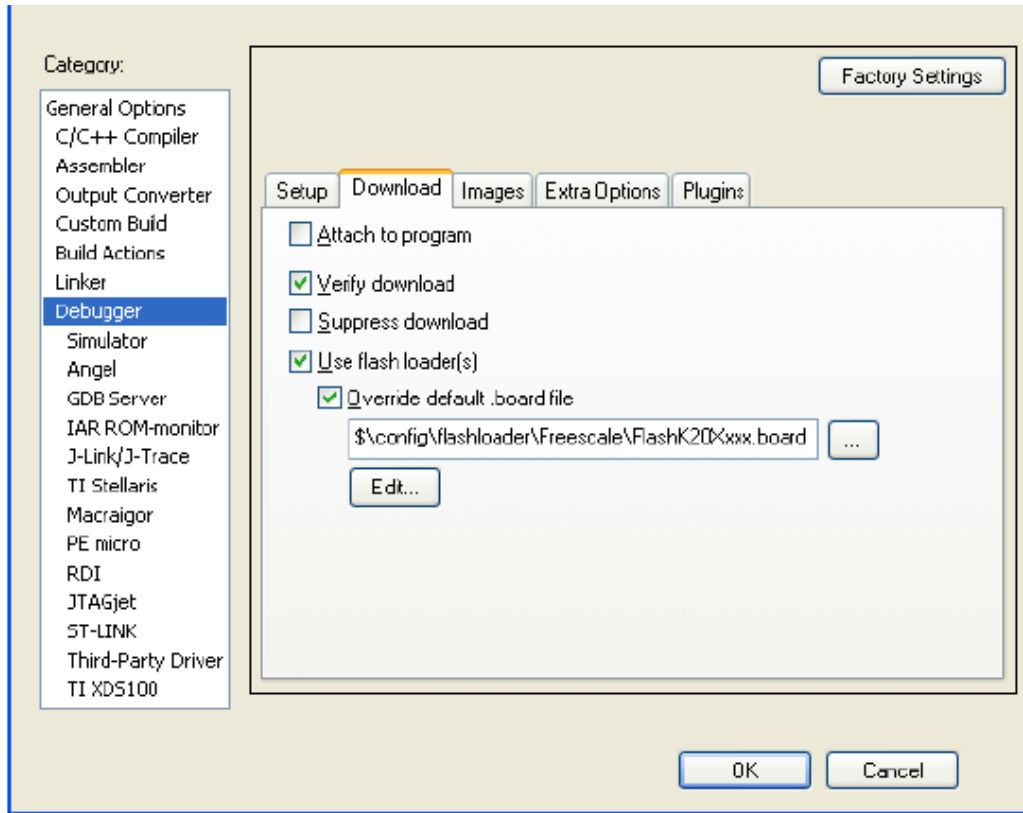

Figure 5.

7. On debugger select driver *PE_micro*.

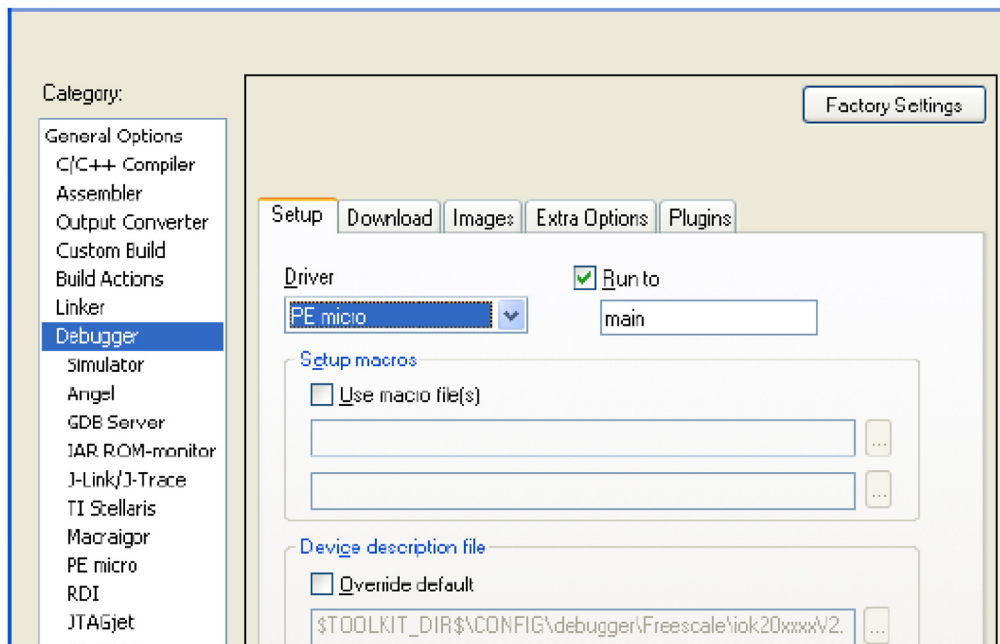

Figure 6.

Demo to enter power modes

- To program and debug the application click on the debug icon.

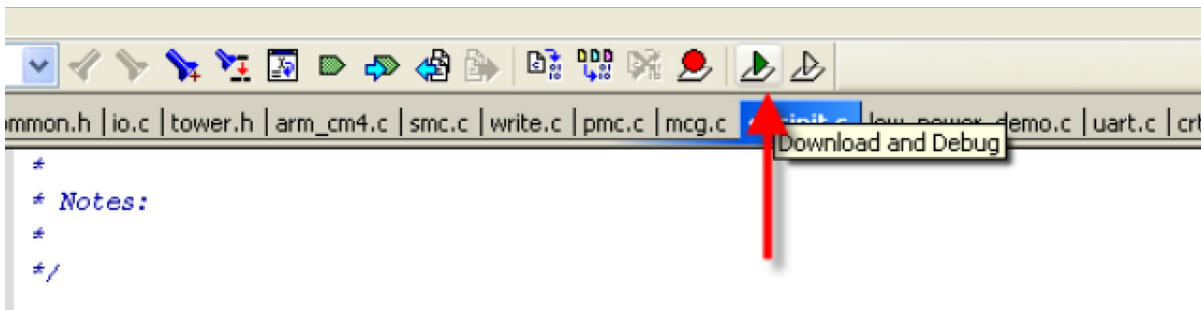

Figure 7.

- Verify that the program was successfully downloaded.

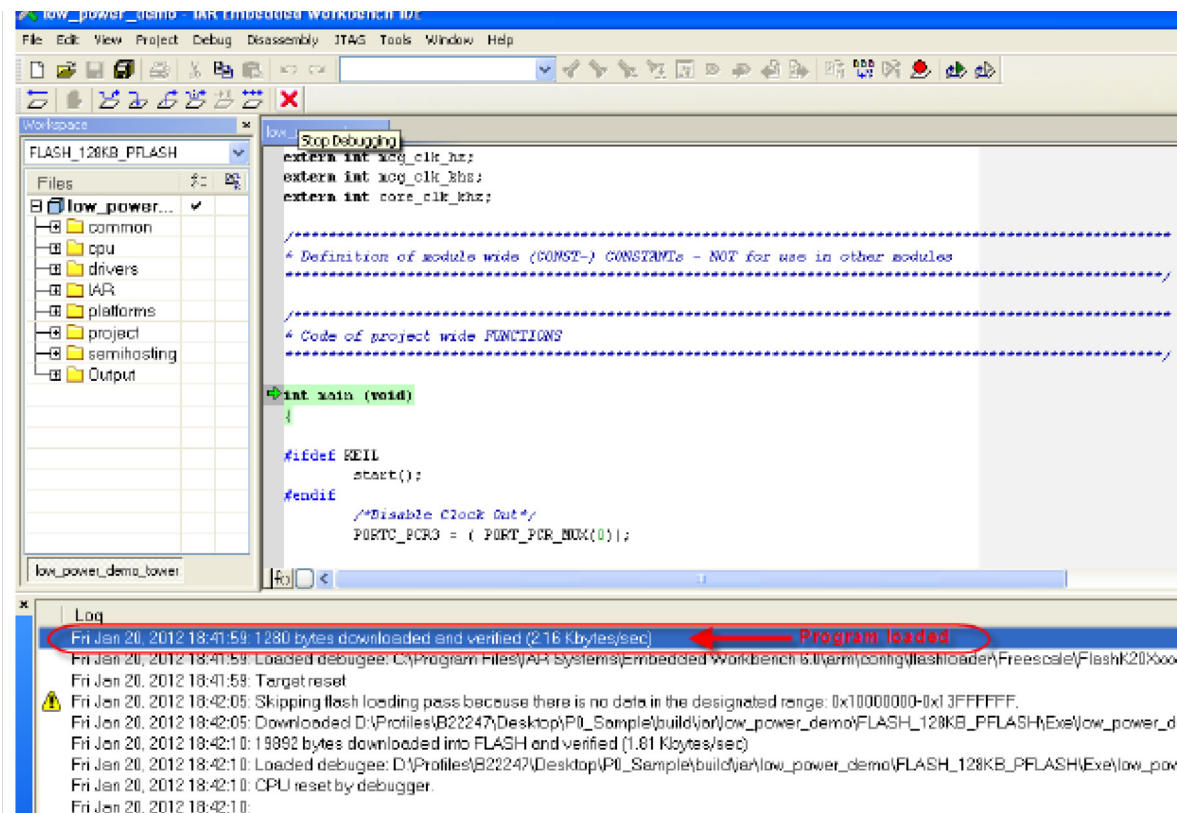

Figure 8.

10. At this point we have successfully downloaded the application, now we need to exit and close the debugger by clicking on the **X** mark as shown in the following screen below:

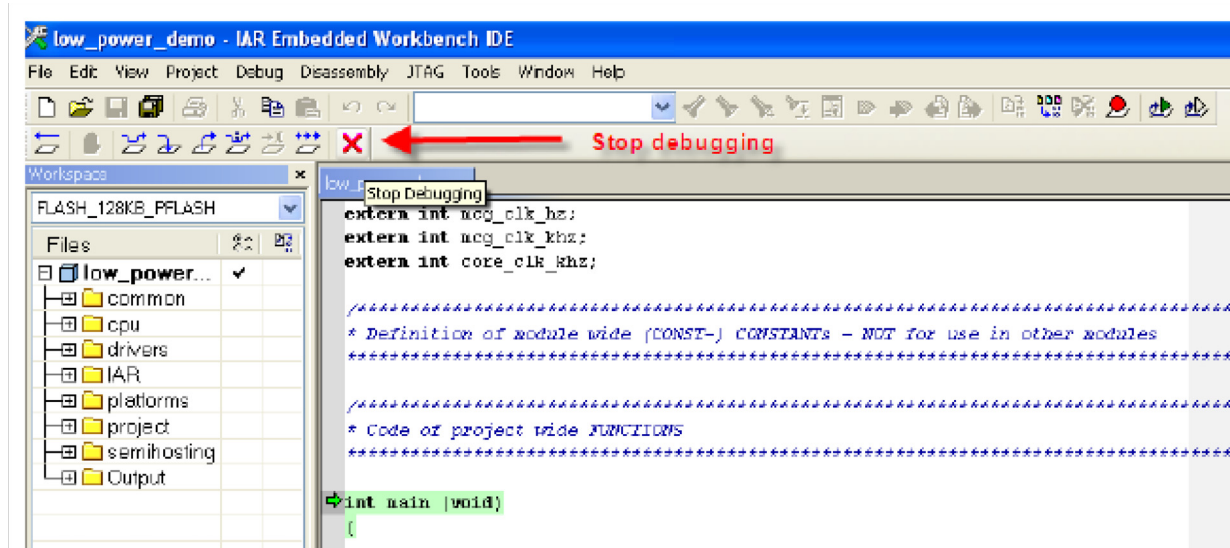

Figure 9.

NOTE

The purpose of stopping the debug session is due to higher current consumption measurements when the debugger is active.

IAR and J-link

For proper operation you must use: **J-Link DLL V4.36i**

You can download it from the following site:

http://www.segger.com/jlink-software.html?step=1&file=JLink_436kl

IAR must be configured as follows:

1. Open your IAR workspace file and select a flash configuration for the project.
2. Open IAR Embedded Workbench IDE.
3. Open the *low_power_demo* workspace.

To do this you can drag and drop the “*low_power_demo.eww*” located on the following path:

{Demo Installation path}\build\iar\low_power_demo

4. In the project options select General options.

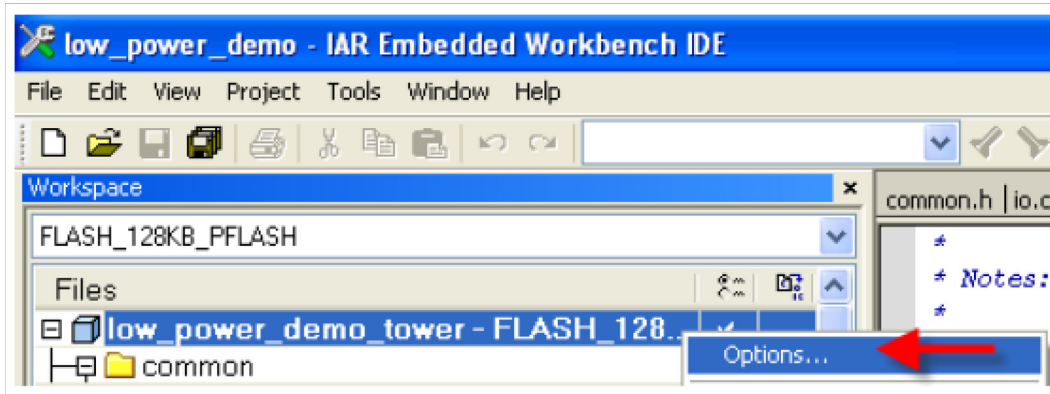

Figure 10.

5. Select Device *MK20DX128xxx5* on the project options as shown below:

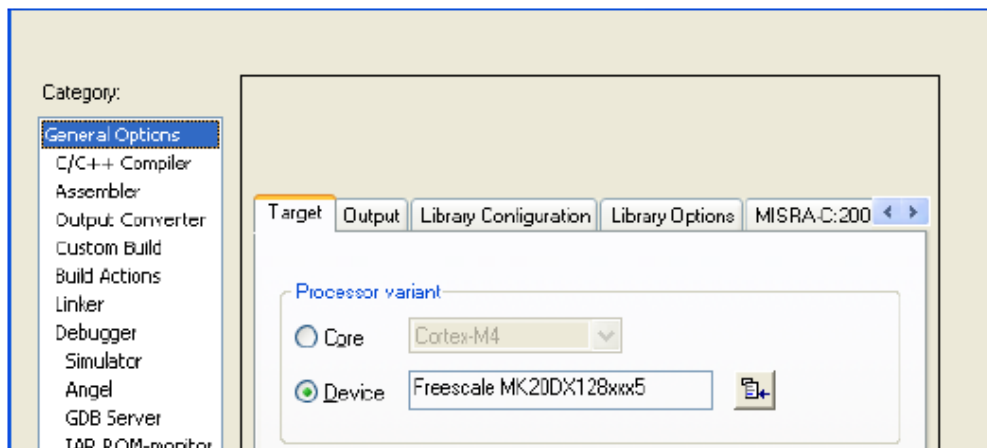

Figure 11.

6. In the Debugger category: Uncheck "Use flash loaders".

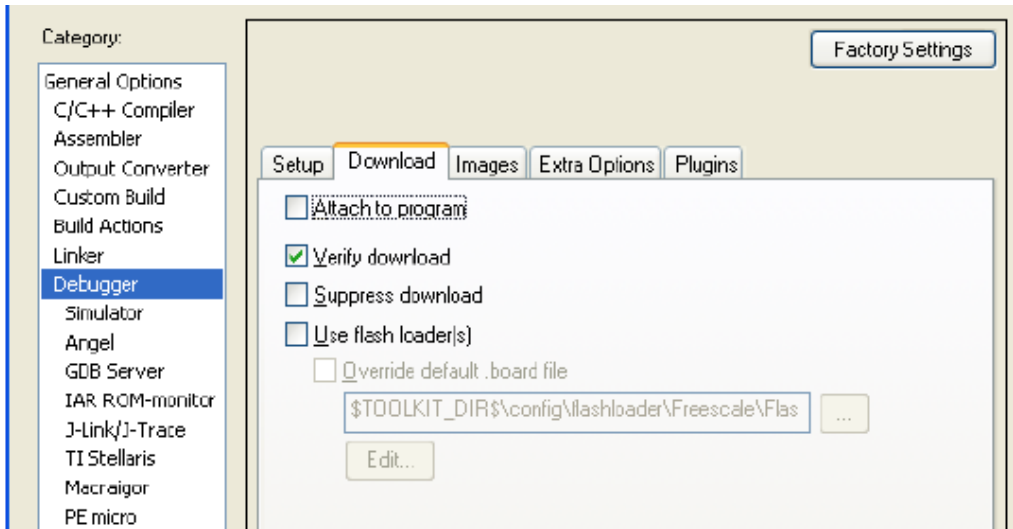

Figure 12.

- In J-link/J-trace Connection window: Select JTAG interface.

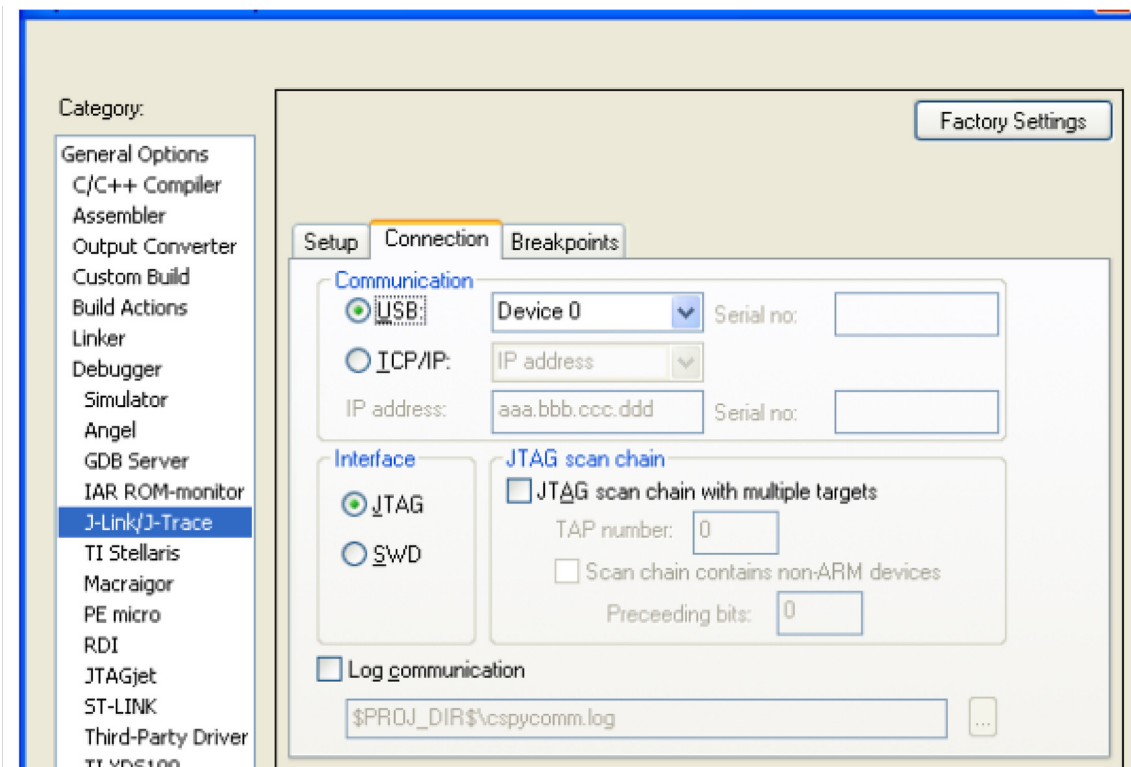

Figure 13.

- To program and debug the application click on the debug icon.

Demo to enter power modes

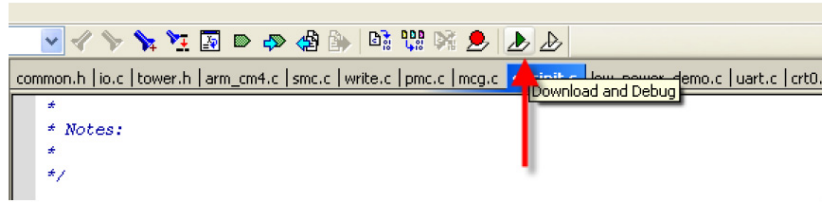

Figure 14.

9. Verify that the program was successfully downloaded.

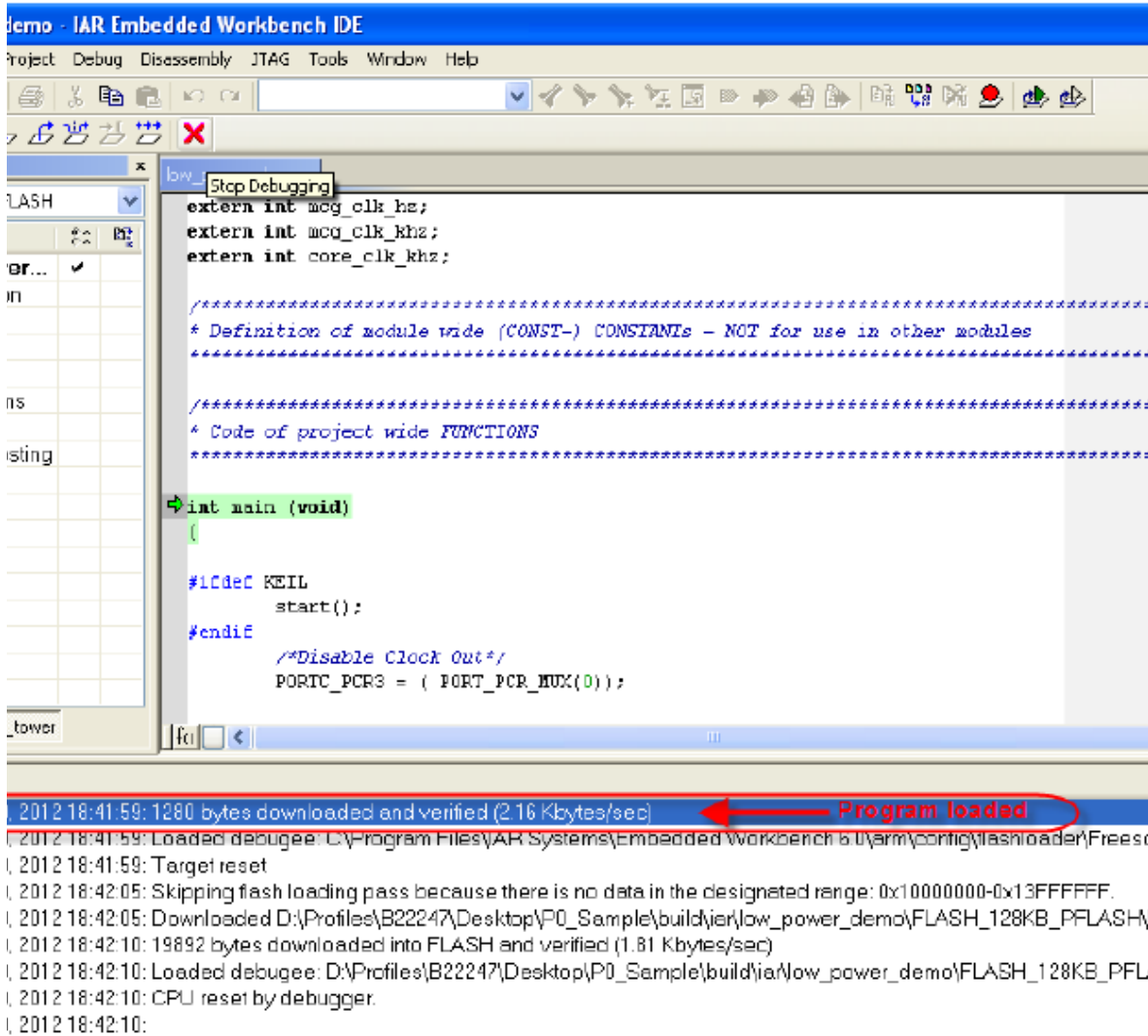

Figure 15.

10. At this point we have successfully downloaded the application, now we need to exit and close the debugger by clicking on the X mark as shown in the following screen:

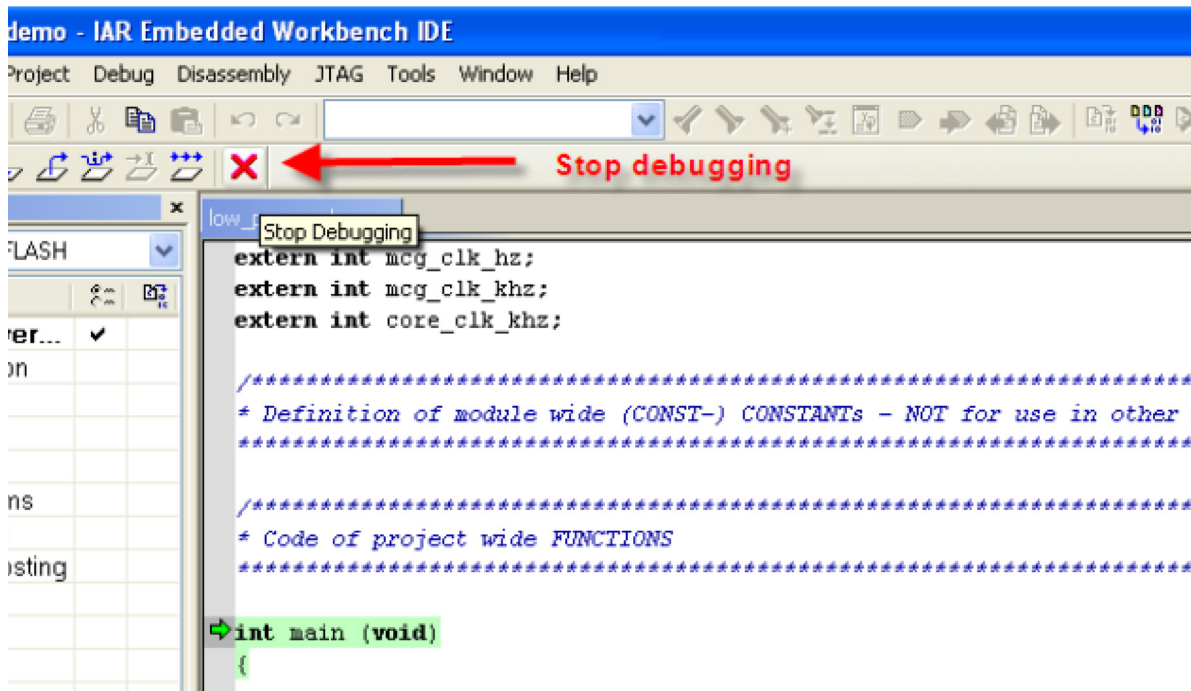

Figure 16.

NOTE

The purpose of stopping the debug session is due to higher current consumption measurements when the debugger is active.

CW MCU V10.1 and OSJTAG/ P&E Multilink

For proper operation with CW10.1, it must be configured as follows:

Update the flash programmer:

1. Click on Flash programmer and import “Flash Task”.

Demo to enter power modes

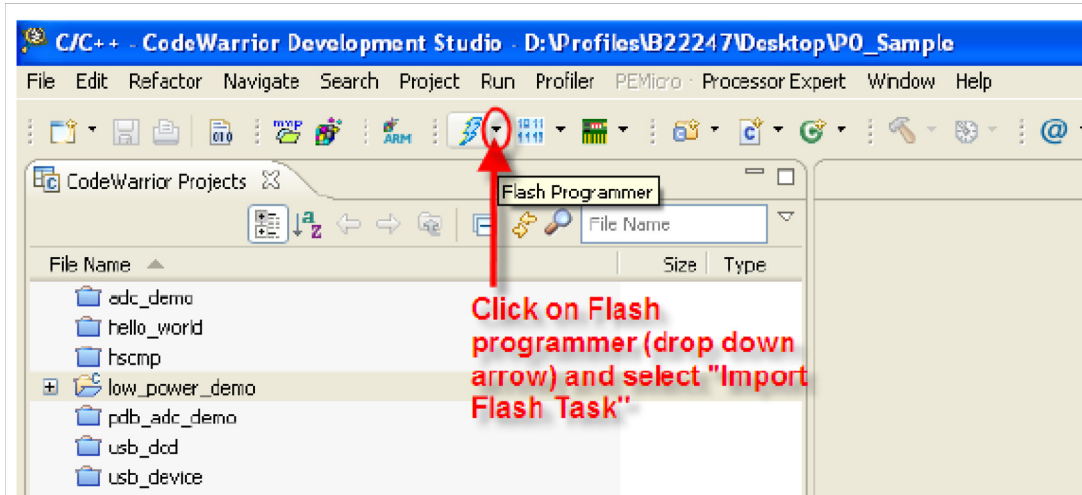

Figure 17.

2. Open the ARM folder, select *K20DX128.xml* and click Open.

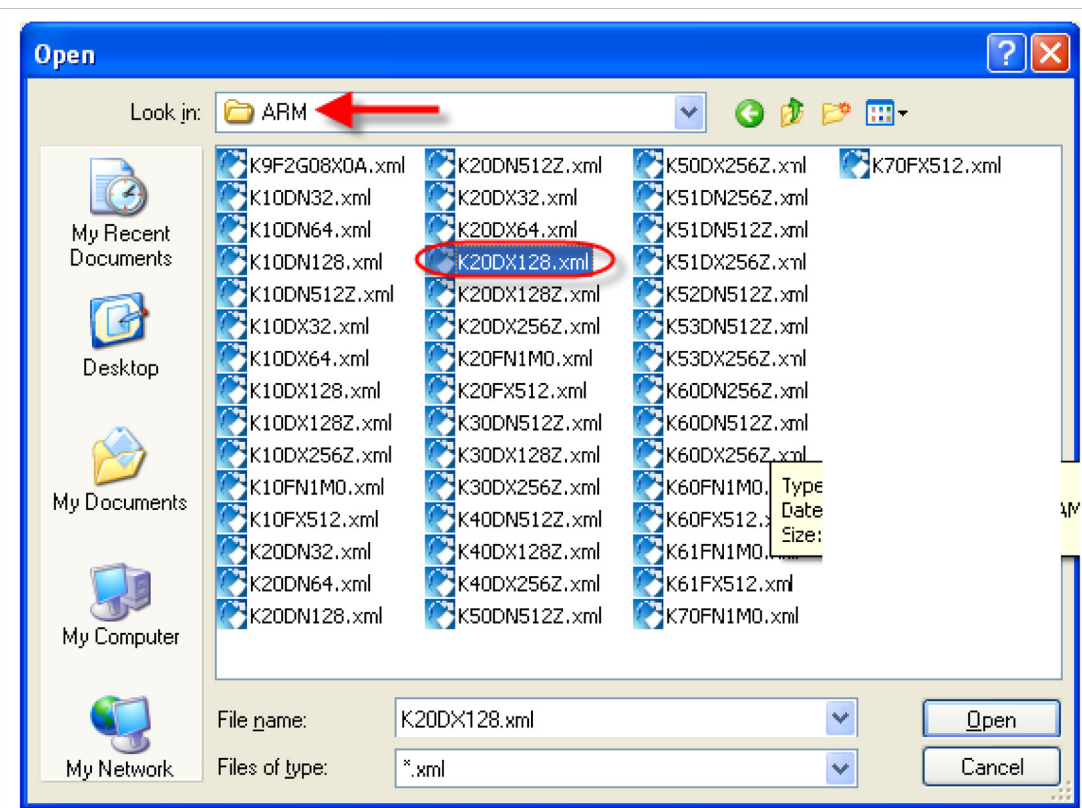

Figure 18.

3. Select FLASH configuration.

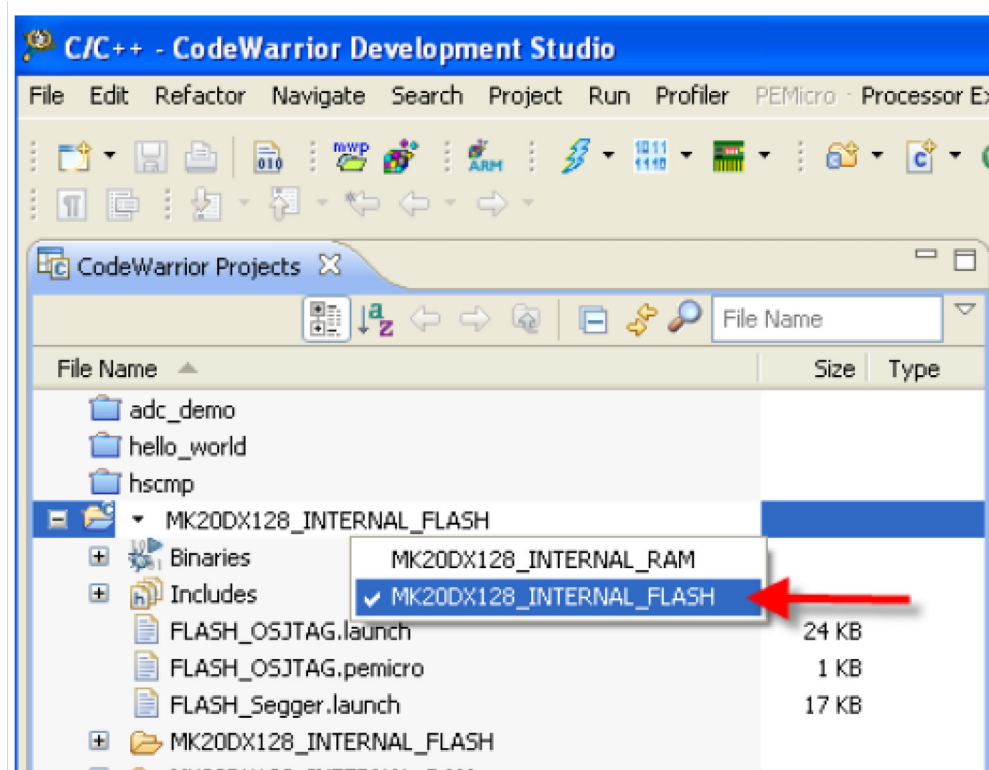

Figure 19.

4. Build the project by clicking on the hammer icon as shown below:

Demo to enter power modes

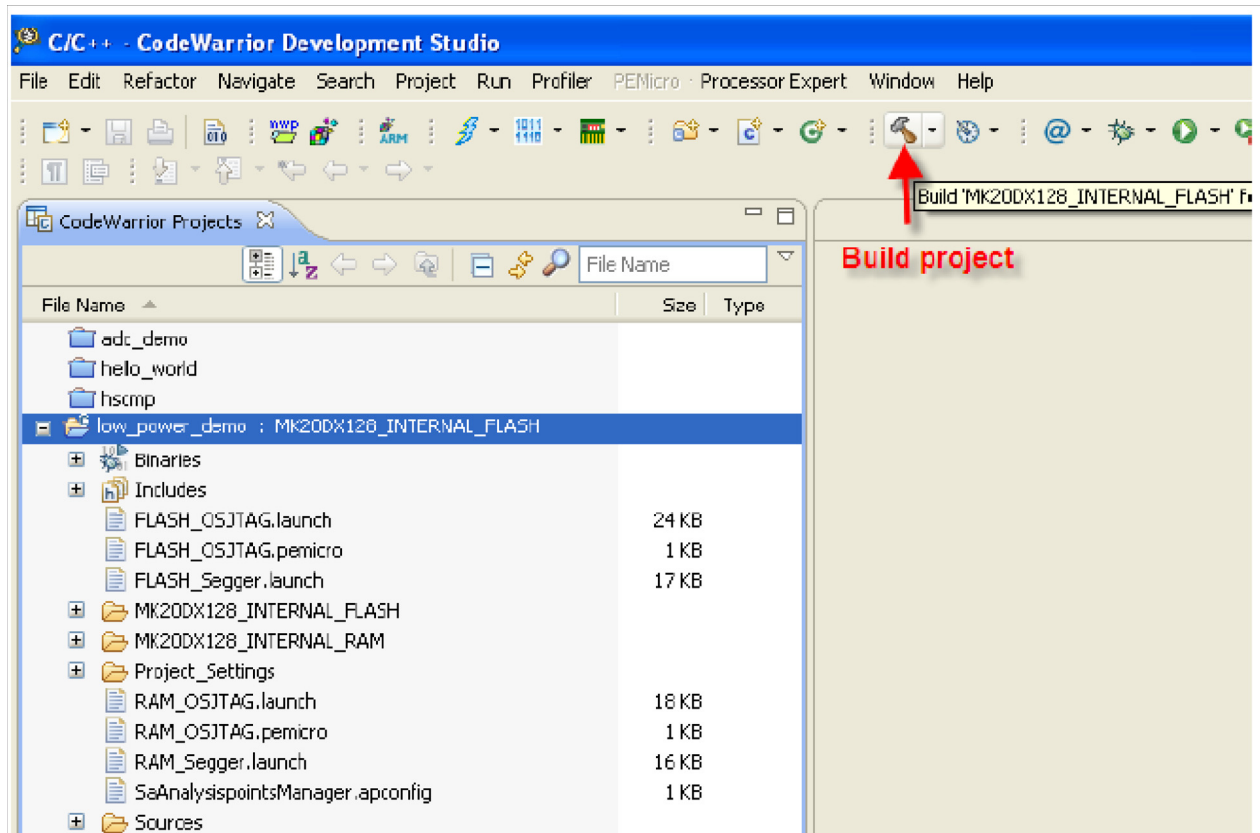

Figure 20.

5. Click on the drop down arrow to select the corresponding debug configuration.

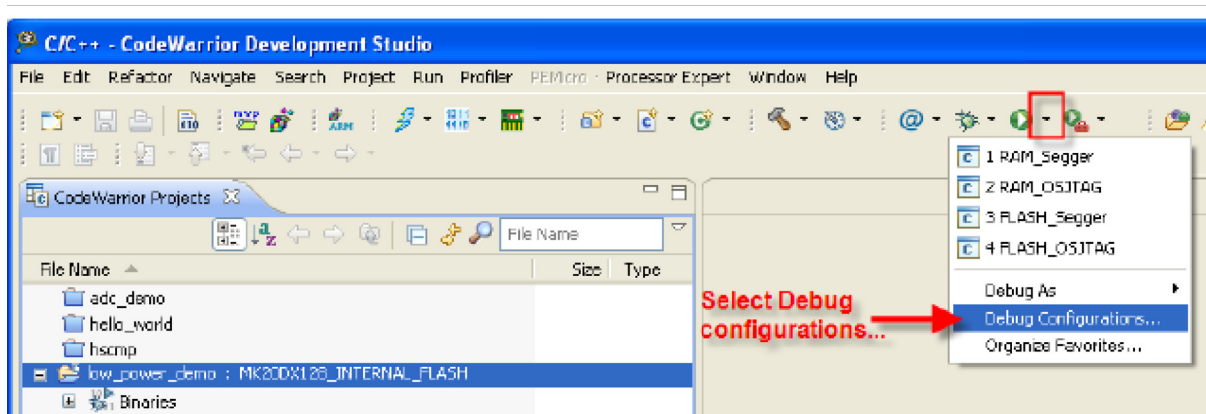

Figure 21.

6. Select FLASH_OSJTAG, go to Debugger tab, open Download section, uncheck “Perform Standard Download”.

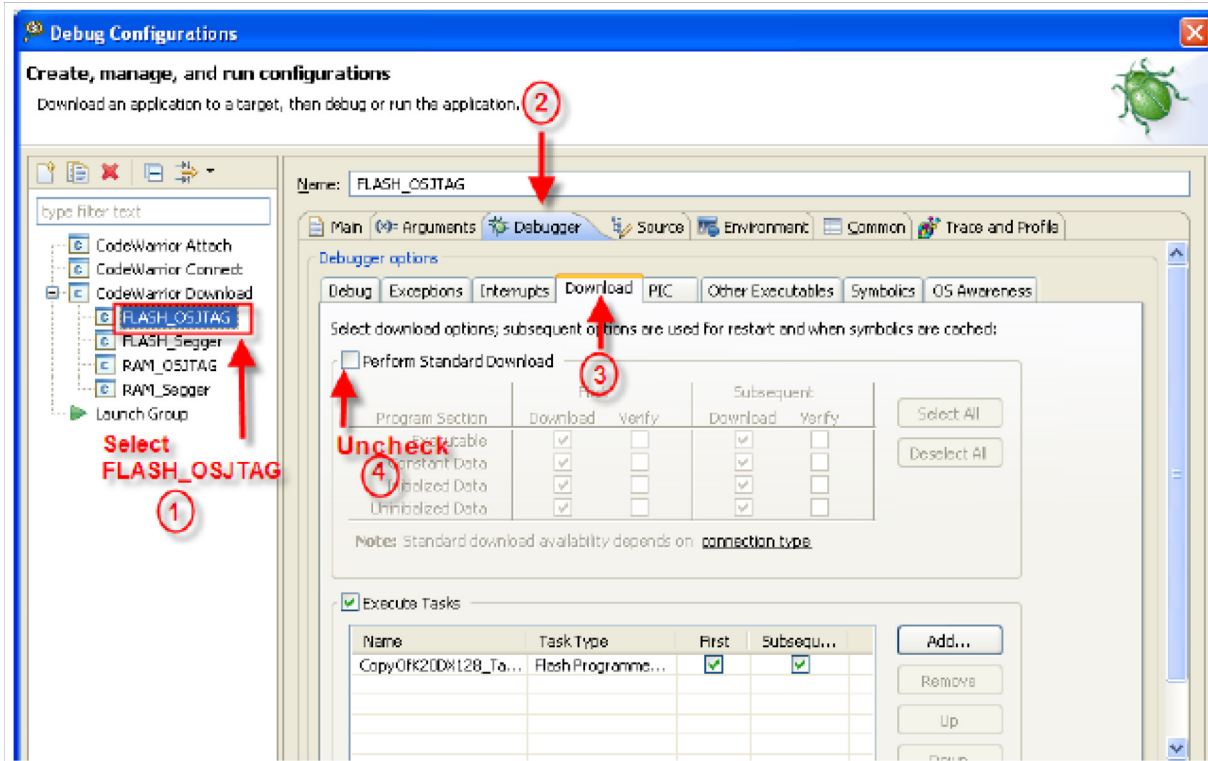

Figure 22.

7. Check the box for Execute Tasks, select the current task and click on Remove.

Demo to enter power modes

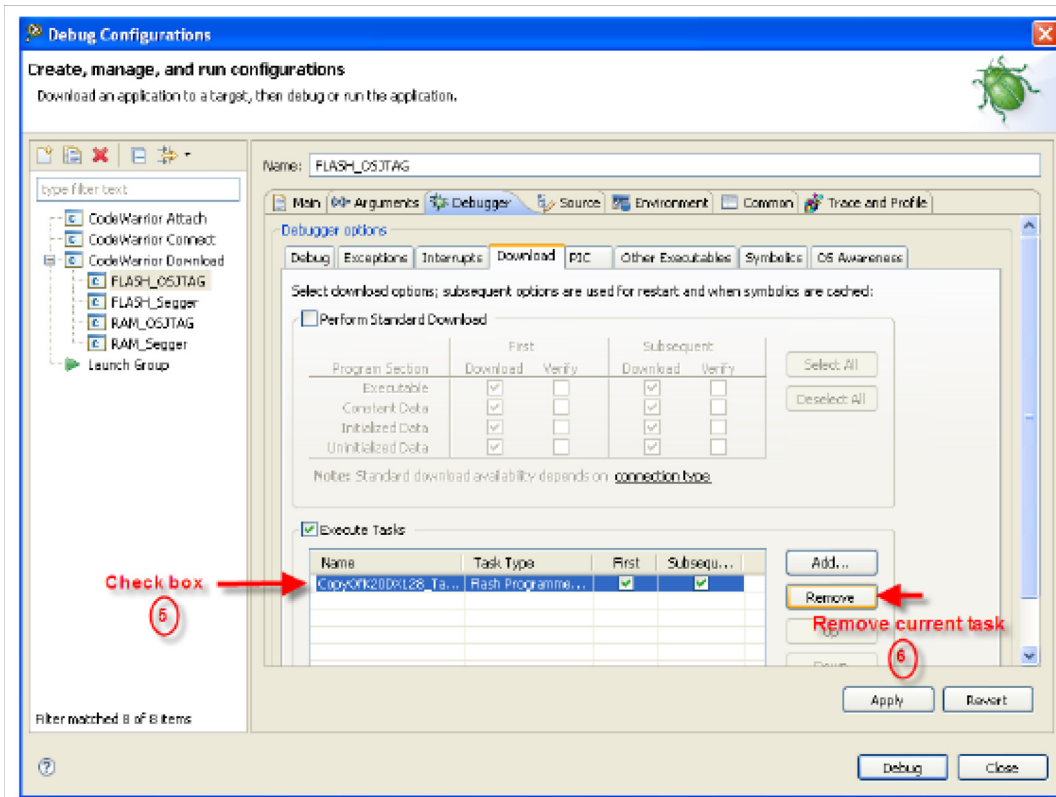

Figure 23.

- Click on Add button and select K20DX128.

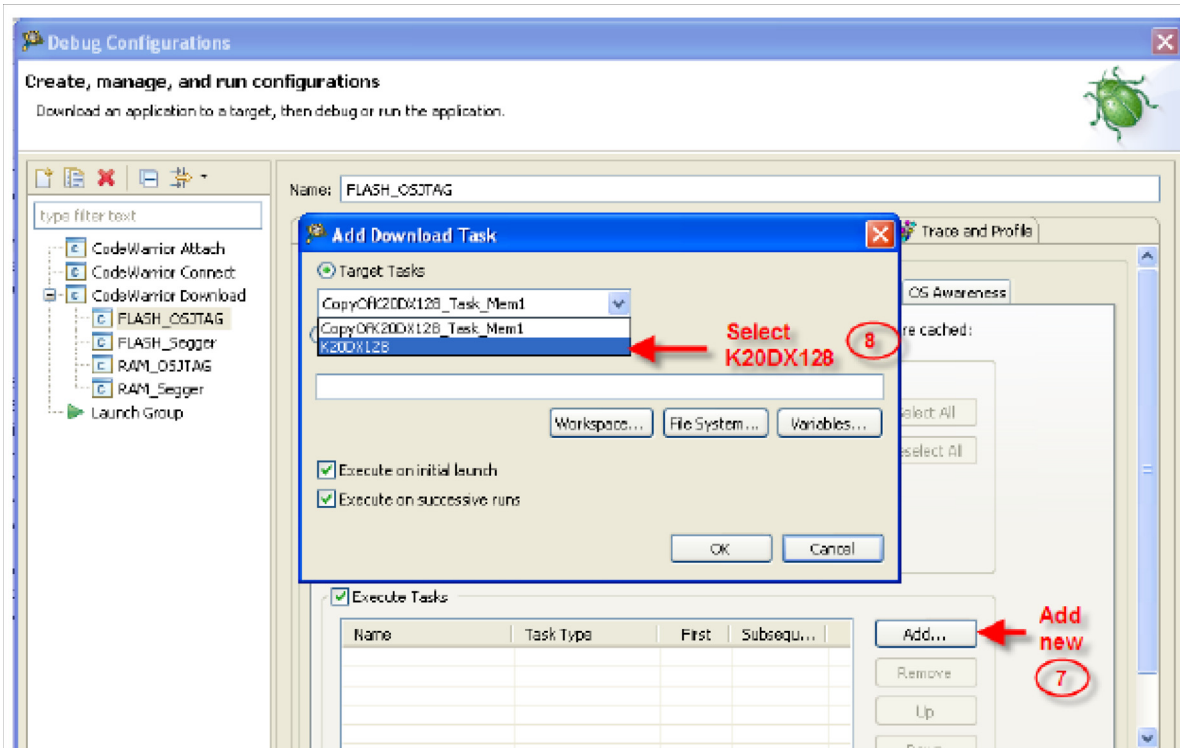

Figure 24.

9. Click Apply and Debug.

Demo to enter power modes

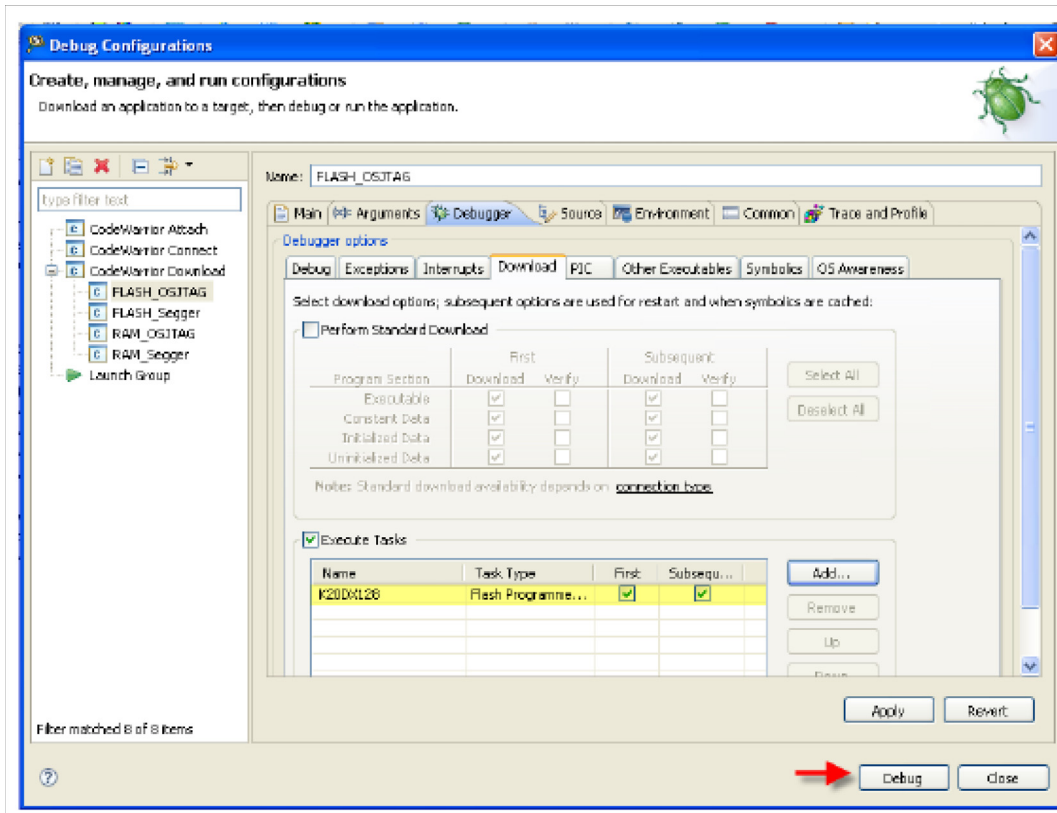

Figure 25.

10. Verify download.

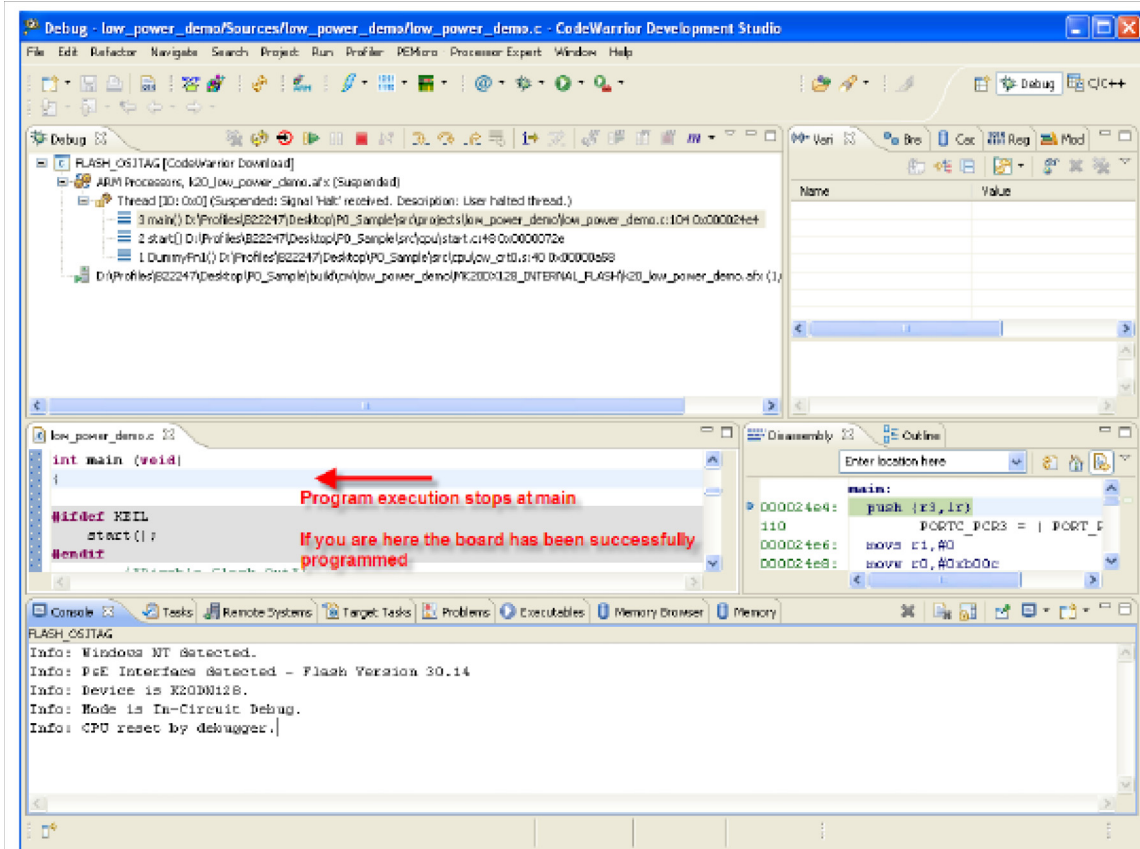

Figure 26.

11. In order to measure current consumption properly, terminate debug session by clicking on the red square button.

Demo to enter power modes

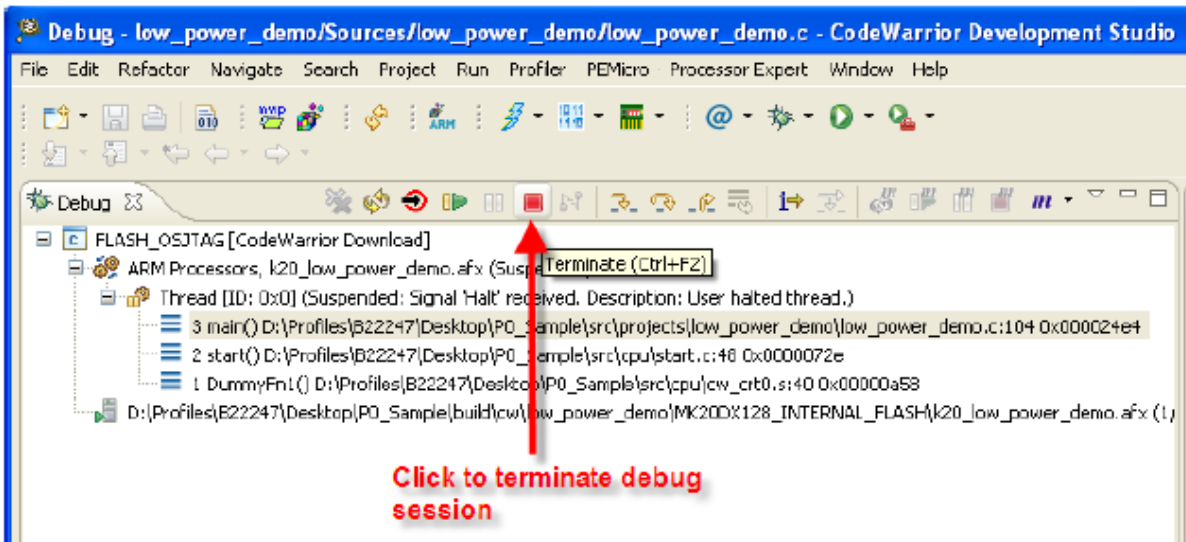

Figure 27.

CW MCU V10.1 and JLink

Follow the same steps as indicated above (for CW MCU V10.1 and OSJTAG/ P&E Multilink), except that in step 6, you must select **FLASH_Segger**.

Select FLASH_Segger, go to Debugger tab, open Download section, uncheck “Perform Standard Download”.

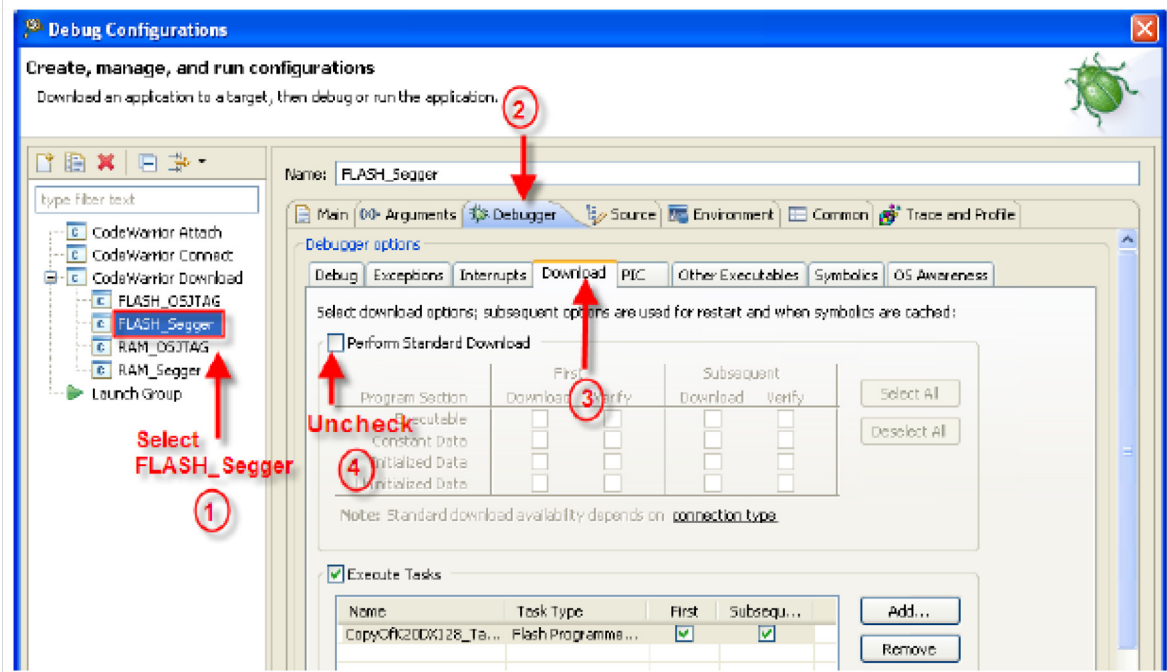

Figure 28.

7.2 Steps to run the demo

Once you have successfully loaded the application to the device and stopped the debugger, you can proceed with the following steps:

1. Open the Terminal application from P&E.
2. Set the port to Port: USB COM, Baud: 115200, Parity: None, Bits: 8 Click on “Open Serial Port”.

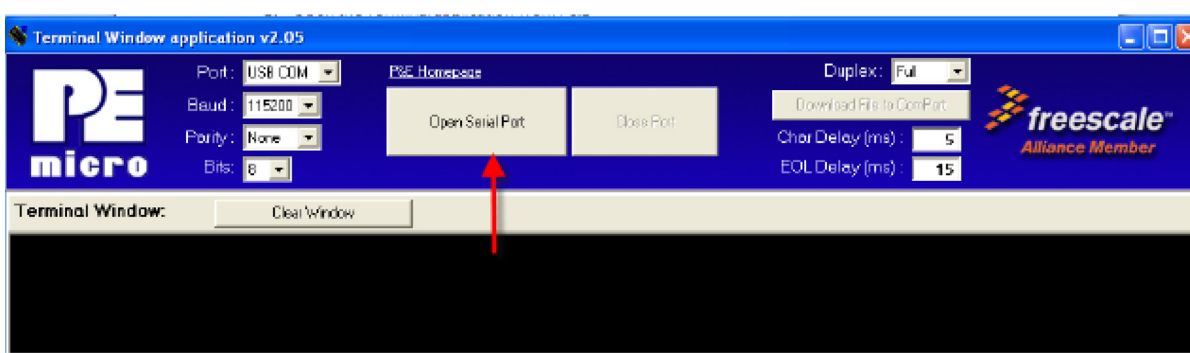

Figure 29.

3. Make sure the port is successfully opened.

Demo to enter power modes

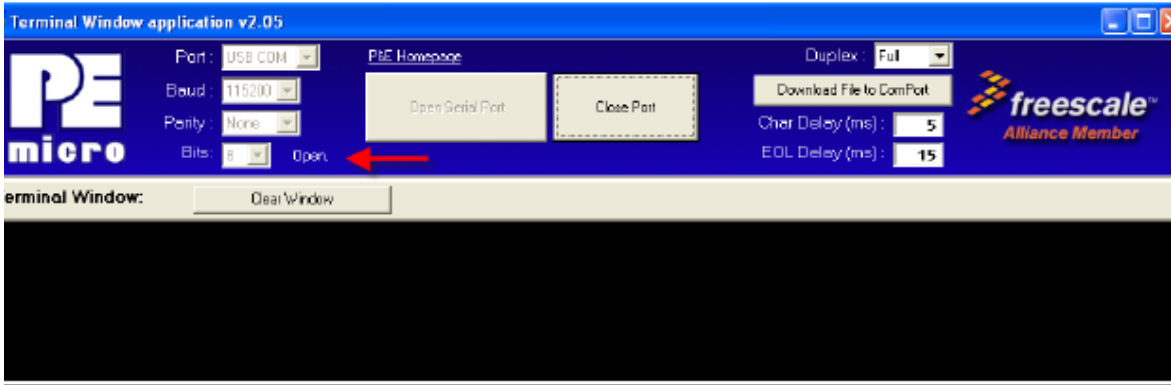

Figure 30.

4. Now click on the reset button of your board.
5. If you look to the Terminal Window you should have all available options displayed.

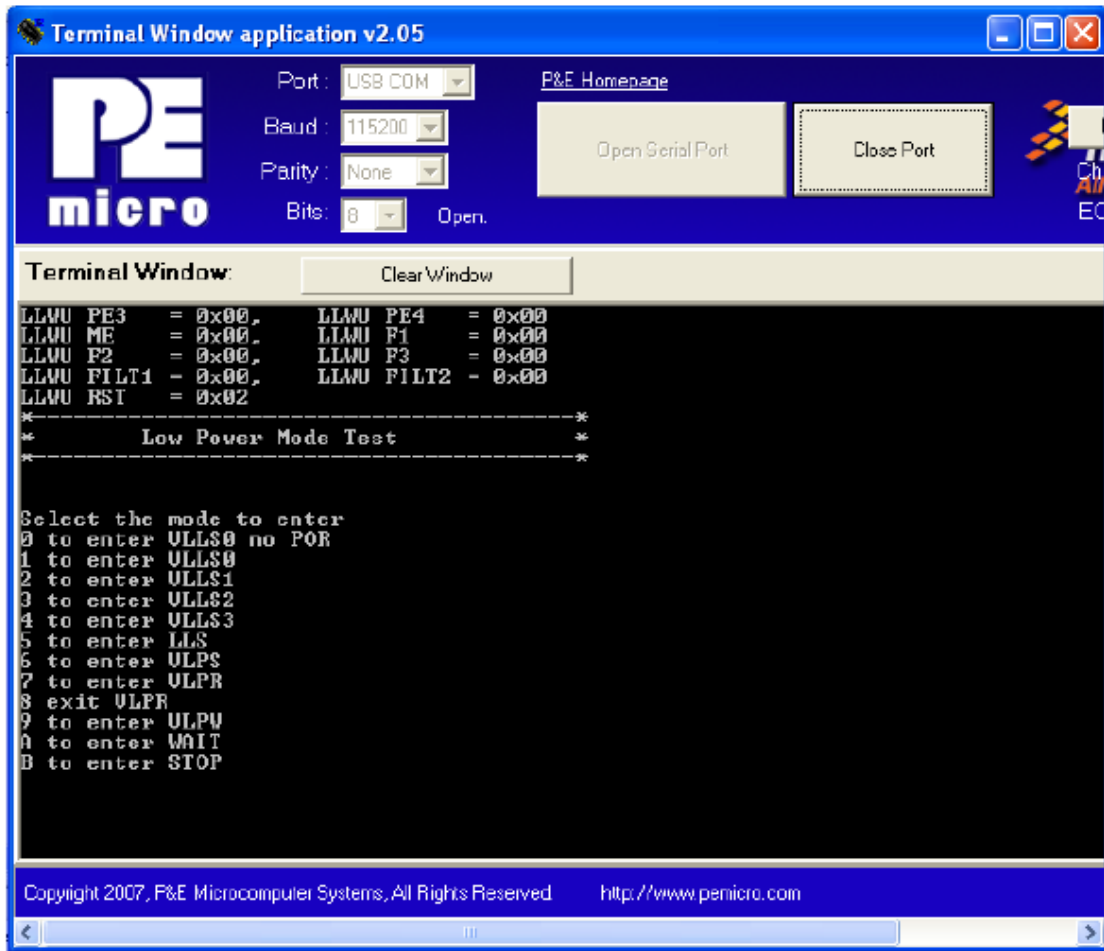

Figure 31.

6. Follow the instructions on the menu.

Example:

To enter Stop Mode:

- Type letter B in the terminal window.

The following message will be displayed:

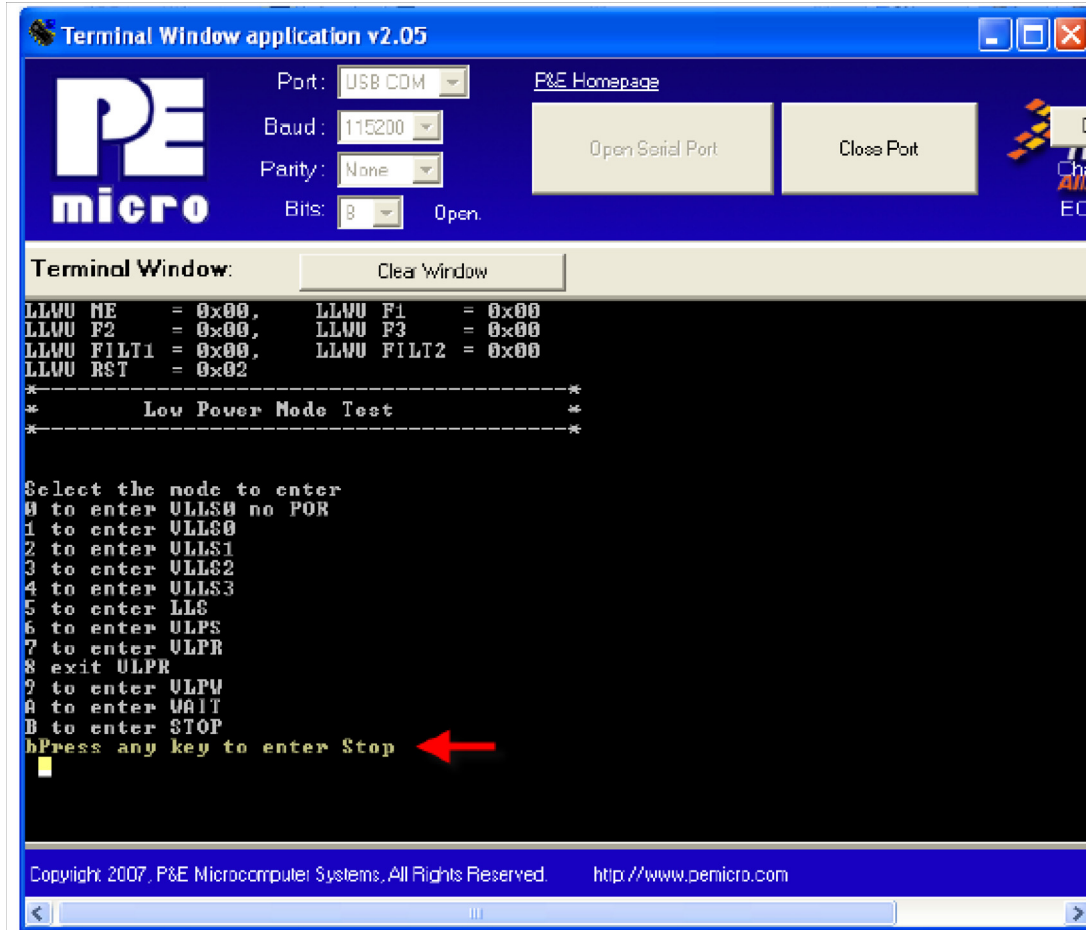

Figure 32.

- Press any key.

The following message is displayed:

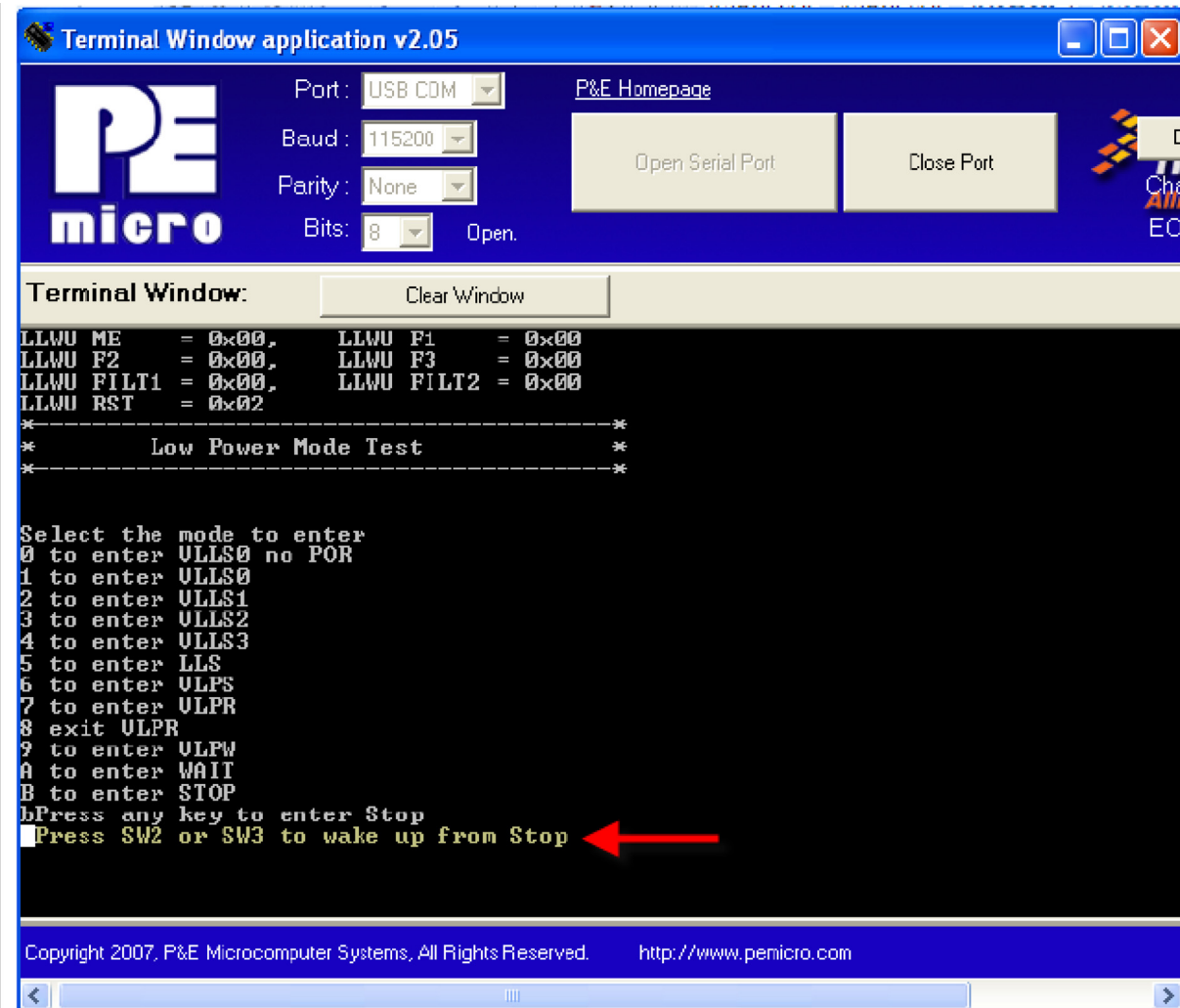

Figure 33.

This means we are currently in stop mode.

- To measure power consumption (depending on your board) you should take off the Jumper that corresponds to MCU power connections.

This is J25 on the TWR-K20D50M Rev. C

NOTE

If you are unsure of the corresponding jumper please refer to your tower board user manual.

- Now measure the device consumption between these terminals:

You must be measuring approximately 320 μ A.

- If you want to exit this low power mode and enter another one press SW2 or SW3:

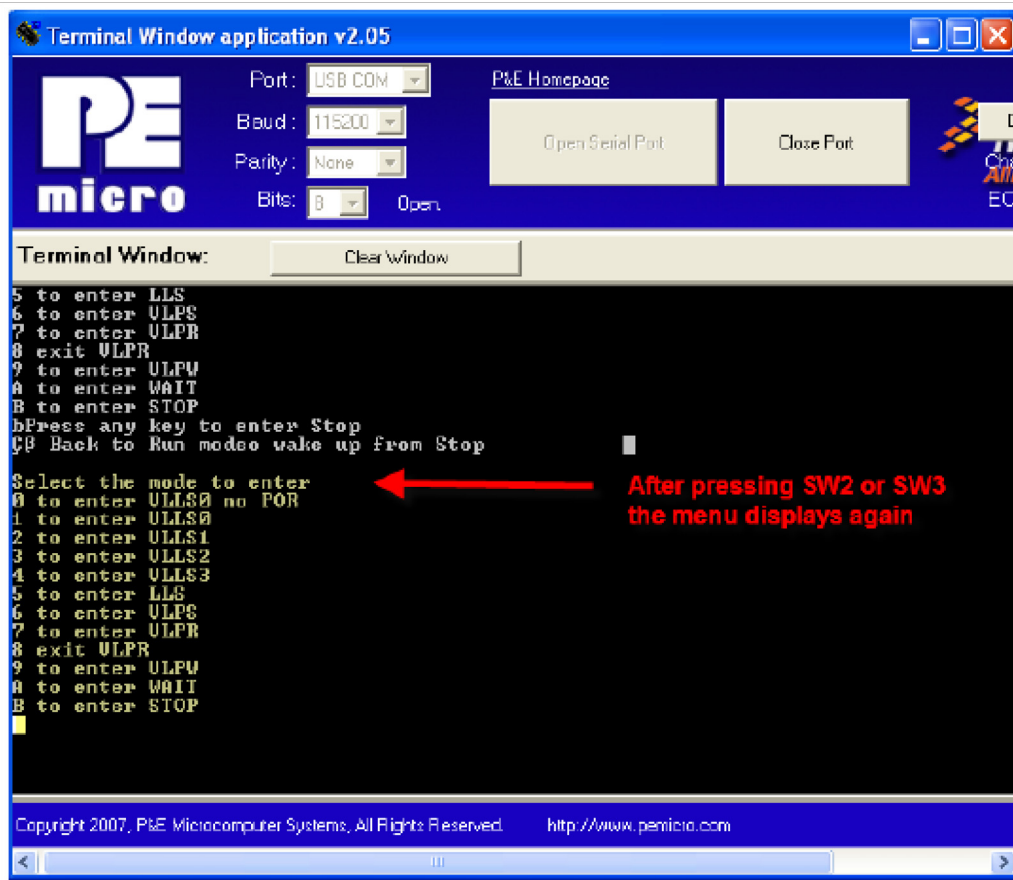

Figure 34.

Now you can follow the steps again to enter a new power mode.

NOTE

You can exit any power mode via reset.

8 Conclusion

When designing for low power you must take into consideration both hardware and software, as both variables are equally important to design a successful power efficient application.

Remember the basics, set pins to a known state, higher core frequency and higher temperature both translate to higher power consumption, disable clocks to unused modules.

9 References

The chapters in this application note contain a summary of the most important details of each topic.

For more details on any of the topics of this document you can refer to the following:

Information about power consumption:

References

- Refer to the device datasheet

Search for “Power consumption operating behaviors”

Information and details about power modes:

- Refer to the device Reference Manual

Search for chapter “Power Management”